

SAMSUNG

GSM TELEPHONE

SGH-U700

SERVICE *Manual*

GSM TELEPHONE



CONTENTS

1. Specification
2. Exploded View and Parts list
3. Chart of Troubleshooting
4. Array course control
5. Block Diagrams
6. PCB Diagrams
7. MAIN Electrical Parts List
8. Reference data
9. Safety Precautions
10. Product Function

Contents

1. Specification

1-1. GSM/CDMA General Specification	1-1
1-2. GSM TX power class	1-2

2. Exploded View and Parts list

2-1. Cellular phone Exploded View	2-1
2-2. Cellular phone Parts list	2-2
2-3. Disassembly	2-4
2-4. Assembly	2-14

3. Chart of Troubleshooting

3-1. Baseband	3-1
3-1-1. Power ON	3-1
3-1-2. System Initial	3-6
3-1-3. SIM Part	3-8
3-1-4. Charging Part	3-10
3-1-5. Microphone Part	3-13
3-1-6. Speaker Part	3-16
3-1-7. Receiver Part	3-20
3-1-8. Camera Part	3-22
3-1-9. LCD	3-26
3-2. RF	3-13
3-2-1. EGSM Receiver	3-30
3-2-2. EGSM Transmitter	3-31
3-2-3. DCS Receiver	3-32
3-2-4. DCS Transmitter	3-33
3-2-5. PCS Receiver	3-34
3-2-6. PCS Transmitter	3-35
3-2-7. UMTS Receiver	3-40
3-2-8. UMTS Transmitter	3-41
3-2-9. BLUETOOTH	3-45

Contents

4. Array course control	
4-1. Downloading Binary Files	4-2
4-2. Pre-requisite for Downloading	4-2
4-3. S/W Downloader Program	4-3
5. Block Diagrams	
6. PCB Diagrams	
7. MAIN Electrical Parts List	
8. Reference data	
8-1. Reference Abbreviate	8-1
9. Safety Precautions	
9-1. Repair Precaution	9-1
9-2. ESD(Electrostaically Sensitive Devices) Precaution	9-2
10. Product Function	

1. Specification

1-1. GSM/WCDMA General Specification

	EGSM 900 Phase 2	DCS1800 Phase 1	PCS1900	WCDMA
Freq. Band[MHz] Uplink/Downlink	880~915 925~960	1710~1785 1805~1880	1850~1910 1930~1990	1920~1980 2110~2170
ARFCN range	0~124 & 975~1023	512~885	512~810	10562~10838
Tx/Rx spacing	45 MHz	95 MHz	80 MHz	190 MHz
Mod. Bit rate/ Bit Period	270.833 kbps 3.692 us	270.833 kbps 3.692 us	270.833 kbps 3.692 us	3.84 Mcps/s
Time Slot Period/Frame Period	576.9 us 4.615 ms	576.9 us 4.615 ms	576.9 us 4.615 ms	10 ms
Modulation	0.3 GMSK	0.3 GMSK	0.3 GMSK	UL:2BPSK DL:QPSK
MS Power	33 dBm~5 dBm	30 dBm~0 dBm	30 dBm~0 dBm	MAX:24(+1,-3) dBm MIN:<-50 dBm
Power Class	5 pcl ~ 19 pcl	0 pcl ~ 15 pcl	0 pcl ~ 15 pcl	CLASS3
Sensitivity	-102 dBm	-100 dBm	-100 dBm	-106.7 dBm
TDMA Mux	8	8	8	-
Cell Radius	35 Km	2 Km	-	-

1-2. GSM TX power class

TX Power control level	EGSM900	TX Power control level	DCS1800	TX Power control level	PCS1900
5	33±2 dBm	0	30±3 dBm	0	30±3 dBm
6	31±2 dBm	1	28±3 dBm	1	28±3 dBm
7	29±2 dBm	2	26±3 dBm	2	26±3 dBm
8	27±2 dBm	3	24±3 dBm	3	24±3 dBm
9	25±2 dBm	4	22±3 dBm	4	22±3 dBm
10	23±2 dBm	5	20±3 dBm	5	20±3 dBm
11	21±2 dBm	6	18±3 dBm	6	18±3 dBm
12	19±2 dBm	7	16±3 dBm	7	16±3 dBm
13	17±2 dBm	8	14±3 dBm	8	14±3 dBm
14	15±2 dBm	9	12±4 dBm	9	12±4 dBm
15	13±2 dBm	10	10±4 dBm	10	10±4 dBm
16	11±3 dBm	11	8±4 dBm	11	8±4 dBm
17	9± 3dBm	12	6±4 dBm	12	6±4 dBm
18	7±3 dBm	13	4±4 dBm	13	4±4 dBm
19	5±3 dBm	14	2±5 dBm	14	2±5 dBm
		15	0±5 dBm	15	0±5 dBm

2. Exploded View and Parts List

2-1. Cellular phone Exploded View

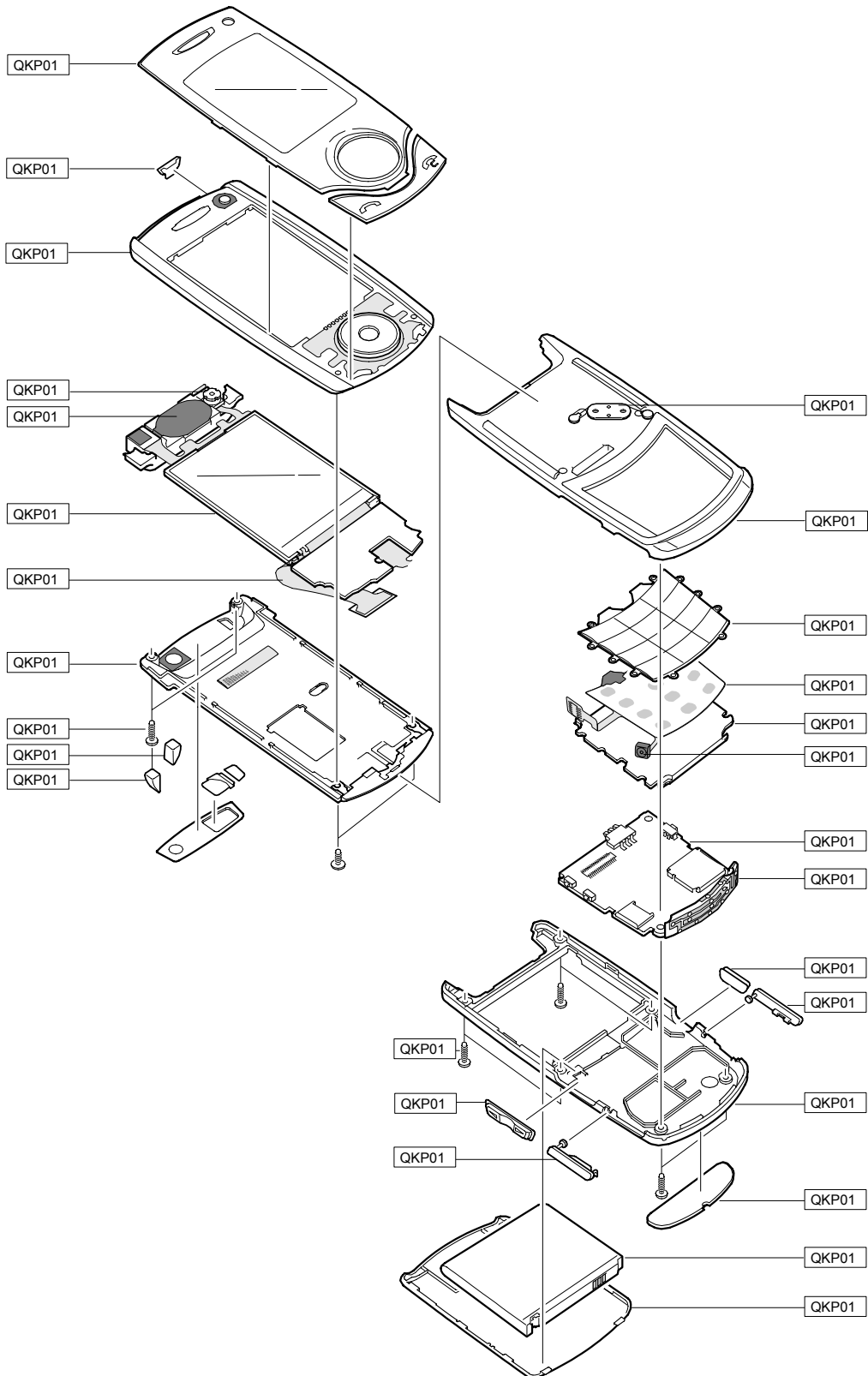

2-2. Cellular phone Parts list

Design LOC		Discription	SEC CODE
QAN02		INTENNA-SGHU700	GH42-01222A
QBA00		ASSY CASE-BATT UPPER	GH98-03988A
QBA01		INNER BATTERY PACK-900MAH	GH43-02398A
QCA01		UNIT-SGHU700 CAMERA	GH59-04220A
QCH03		ASSY CASE-LED HOLDER	GH98-04251A
QCR03		SCREW-MACHINE	6001-001811
QCR12		SCREW-MACHINE	6001-001530
QKP01		ASSY KEYPAD-MAIN(XEF/SB)	GH98-03995A
QLC01		MEA-LCD MODULE KIIT	GH97-07710A
QMP01		PBA MAIN-SGHU700	GH92-03467A
QPC01		MEA-SLIDE FPCB KIT	GH97-07709A
QRE04		PMO-DECO REAR	GH72-37458A
QSC05		ASSY CASE-LOWER SCREW CAP L	GH98-04427A
QSC06		ASSY CASE-LOWER SCREW CAP R	GH98-04428A
QSH01		ASSY CASE-SHIELD BRACKET	GH98-03987A
QSP02		UNIT-SGHU700 SPK MODULE	GH59-04495A
QVO01		PMO-KEY VOLUME	GH72-37466A
QME01		UNIT-SGHU700 KEY PAD FPCB ASS'	GH59-04121A
	QMI01	AS-SGHI607 MIC	GH81-06077A
QFU01		ASSY CASE-SLIDE UPPER WHEEL	GH98-05024A
	QCK01	PMO-KEY POWER V3	GH72-39119A
QFR01		ASSY CASE-FRONT S/LOWER(TIM)	GH98-05367A
	QFL01	ASSY CASE-SLIDE LOWER	GH98-03986A
	QHI01	ASSY HINGE-LINK HINGE	GH98-03994A
	QFR02	ASSY CASE-FRONT(TIM)	GH98-05365A
QRE01		ASSY CASE-REAR(TIM)	GH98-05322A
	QCK01	PMO-KEY CAM	GH72-37468A
	QSD01	PMO-COVER MICRO SD	GH72-37472A
	QRF03	PMO-COVER EARJACK	GH72-37473A

Discription	SEC CODE
BAG PE	6902-000634
CBF INTERFACE-DATA LINK CABLE	GH39-00444B
ADAPTOR-SGHE690,SIL,EU,A_TYPE	GH44-01361B
S/W CD-SGHU700 PC STUDIO 3.1	GH46-00450A
UNIT-EARPHONE,SGHE490,SIL,B-TY	GH59-03883B
LABEL(R)-WATER SOAK	GH68-09361A
LABEL(R)-MAIN(TIM)	GH68-14910F
MANUAL USERS-TIM ITALIAN	GH68-14966A
CUSHION-CASE TA2 MA2	GH69-05116A
BOX(P)-UNIT MAIN(TIM)	GH69-05474K
RMO RUBBER-KEY CAM	GH73-09876A
RMO RUBBER-PMIC	GH73-09996A
MPR-VINYL BOHO MAIN STA	GH74-29774A
MPR-TAPE COVER LCD	GH74-30596A
TAPE INSU-J TAG	GH74-33005A
TAPE-PYRESIA CAM	GH74-33076A
TAPE-SHIELD B GND	GH74-33077A
TAPE-PYREXIA PAM	GH74-33346A
TAPE INSU	GH74-33348A
AS-SGHU700 CAMERA TAPE(VGA)	GH81-06351A
AS-SGHU700 CAMERA TAPE(3M)	GH81-06352A

2-3. Disassembly

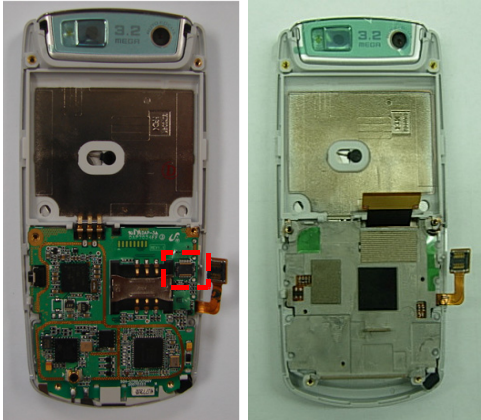
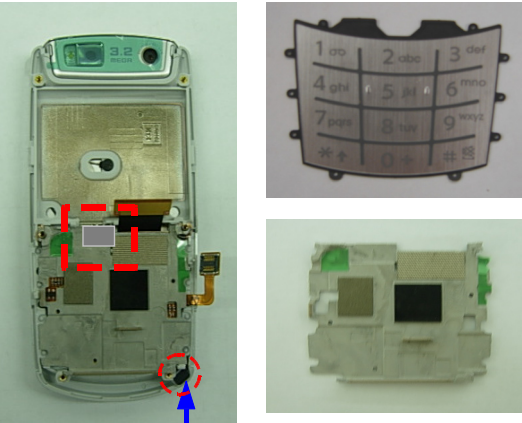
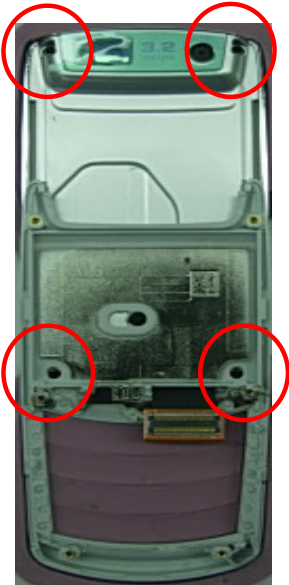
<p>1</p>  <p>Use the disjoining hole</p>	<p>2</p> 
<p>1) Detach a RF sheet and unscrew the 6 points. 2) Separate the REAR from the FRONT ass'y using assembly stick.</p> <p>* Caution</p> <p>1) Be care of scratch and molding damage.</p>	<p>1) Disjoin the connectors from the PBA.</p> <p>* Caution</p> <p>1) Be care of scratch and molding damage. 2) Be care of damage to the FPCBs.</p>
<p>3</p>  <p>Disjoint the MIC</p>	<p>4</p> 
<p>1) Disjoin the tape in the red box. 2) Disjoin the MIC. 3) Disjoin the shield can and key pad.</p> <p>* Caution</p> <p>1) Be care of scratch and molding damage. 2) Be care of damage to the FPCB.</p>	<p>1) Unscrew the 4 points.</p> <p>* Caution</p> <p>1) Be care of damage to the FPCBs. 2) Be care of scratch and molding damage.</p>



- 1) Disassemble the slide lower into the slide upper. (follow an arrow).
- 2) Disassemble the slide FPCB into hole of slide lower.

※ **Caution**

- 1) Be care of scratch and molding damage.

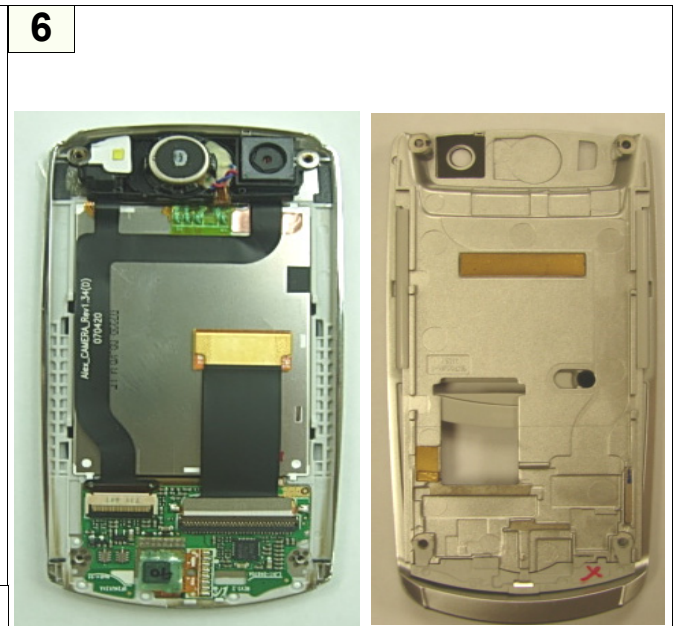

- 1) Disassemble the UPPER by using a assembly stick.

※ **Caution**

- 1) Be care of scratch and molding damage.

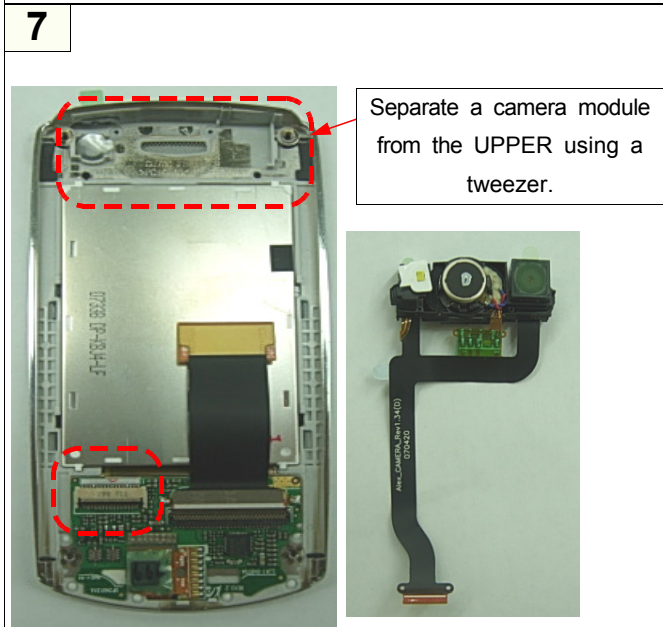

- 1) Separate a camera module from the UPPER.
- 2) Separate a camera FPCB from LCD module.

※ **Caution**

- 1) Be care of scratch and molding damage.
- 2) Be care of damage to F-PCB.

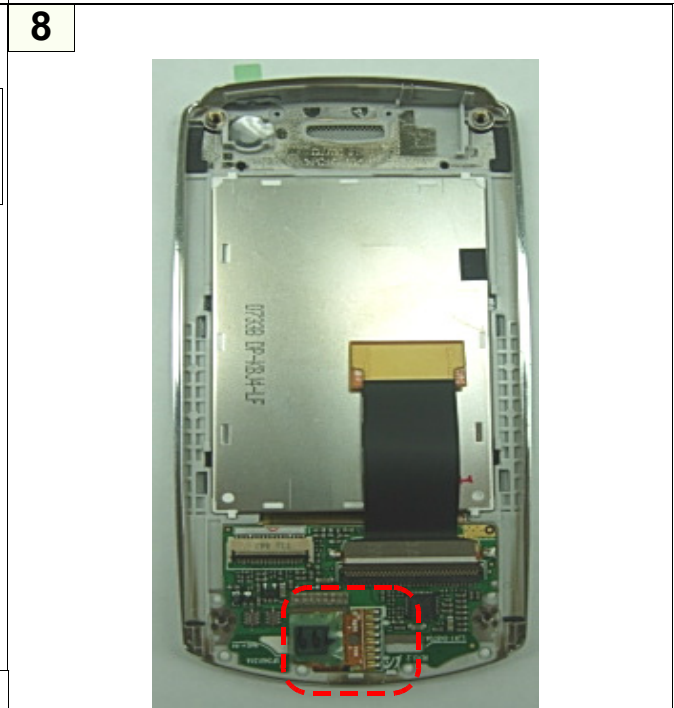

- 1) Separate the LCD module from the UPPER.

※ **Caution**

- 1) Be care of scratch and molding damage.
- 2) Be care of damage to LCD FPCB..

9

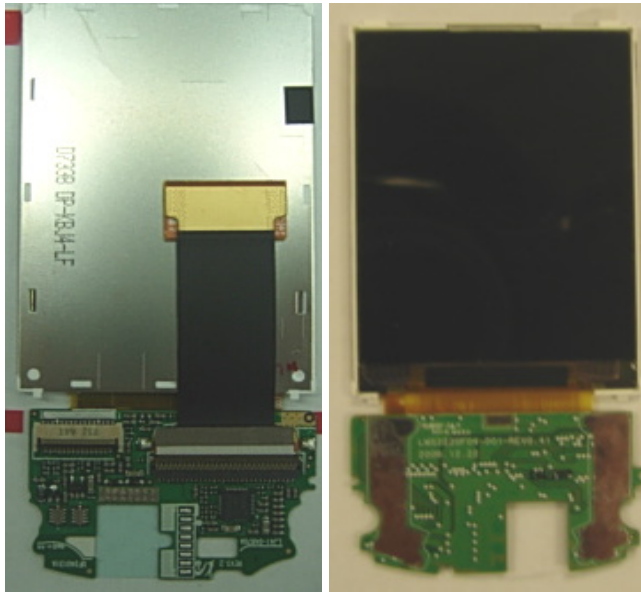

1) Take the LCD out.

※ **Caution**

1) Be care of scratch and molding damage.

1) Be care of damage to camera FPCB..

2-4. Assembly

<p style="text-align: center;">1</p> 	<p style="text-align: center;">2</p> 
<p>1) Solder speaker/motor module to the pad of camera module.</p> <p>* Caution</p> <p>1) Be care of damage to the F-PCB of speaker module</p>	<p>1) Assemble the power key and LED into the speaker module.</p> <p>2) Keep the orders.</p> <p>* Caution</p> <p>1) Be care of damage to the F-PCBs.</p>
<p style="text-align: center;">3</p> 	<p style="text-align: center;">4</p> 
<p>1) Attach the tapes to the designated 2 points.</p> <p>* Caution</p> <p>1) Be care of scratch and molding damage.</p> <p>2) White holder should not be attached on the LED.</p>	<p>1) Check the external damage of LCD module.</p> <p>* Caution</p> <p>1) Be care of scratch and molding damage.</p> <p>2) Be care of damage to the F-PCB of speaker module.</p>

5

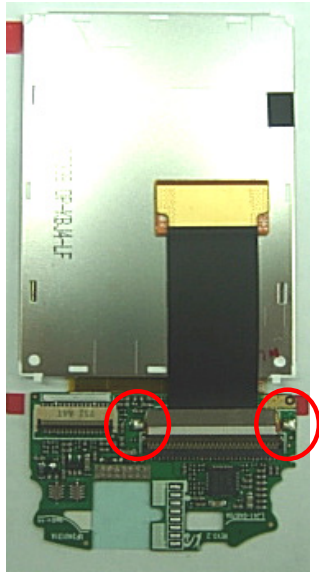

- 1) Assemble the slide FPCB into the LCD module.
- 2) Solder the side pads of slide FPCB.

※ **Caution**

- 1) Be care of damage to F-PCB of slide.
- 2) Be care of solder longer than 3 seconds.

6

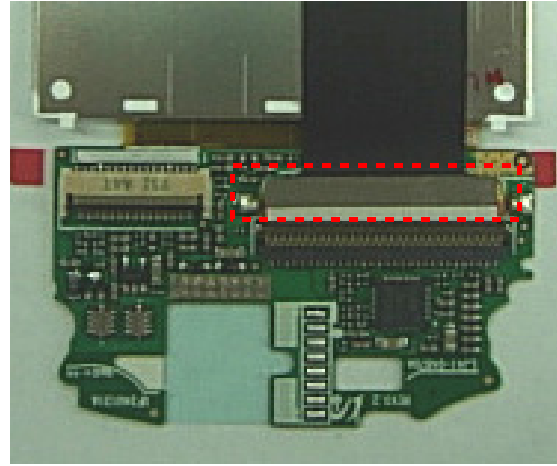

- 1) Attach the tape to the designated point.

※ **Caution**

- 1) Be care of scratch and molding damage.

7



- 1) Check the external damage of slide upper.

※ **Caution**

- 1) Be care of scratch and molding damage.

8

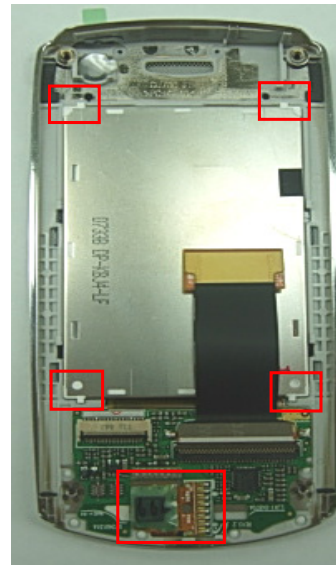

- 1) Place the LCD module like the picture.
- 2) Attach the touch FPCB to the designated point.
- 3) Solder the pads of touch FPCB.

※ **Caution**

- 1) Be care of damage to the touch F-PCB
- 2) Please keep the guide silks attaching touch F-PCB.

9

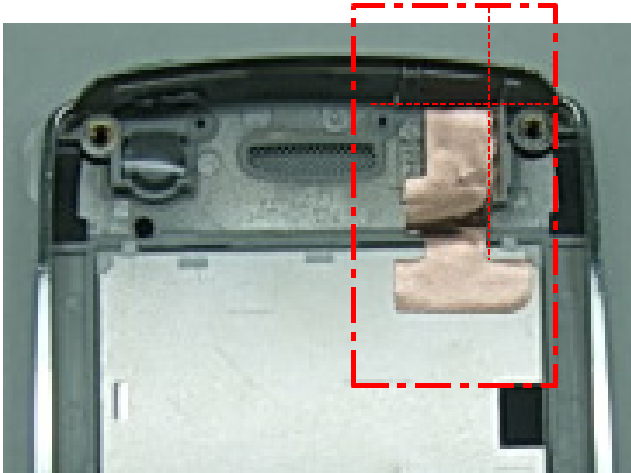

- 1) Attach the copper tape to the designated point.
 ※ **Caution**
 1) Be care of damage to the LCD module.

10

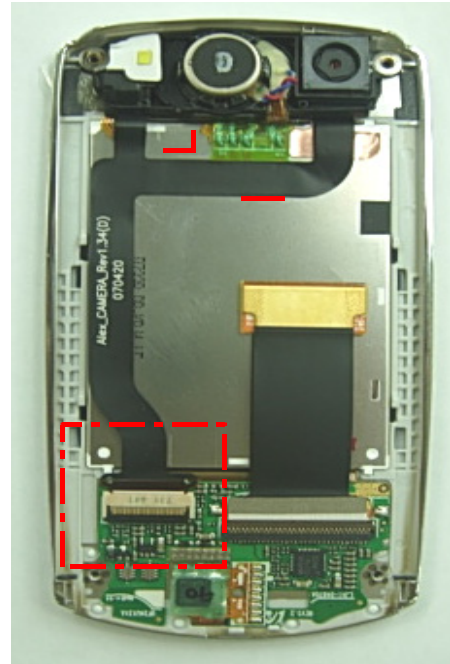

- 1) Assemble the camera module into the LCD module.
 ※ **Caution**
 1) Be care of scratch and molding damage.

11

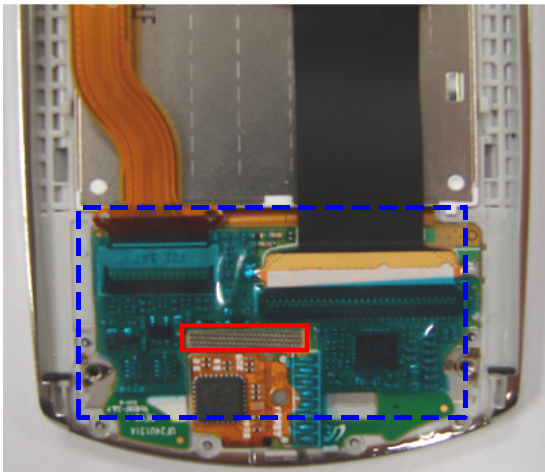

- 1) Attach tapes to the designated point.
 ※ **Caution**
 1) Be care of scratch and molding damage.
 2) Green tape should not be attached in the red box.

12

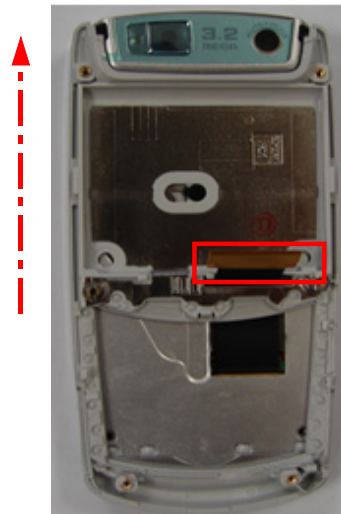

- 1) Assemble the slide FPCB into hole of slide lower.
 2) Assemble the slide lower into the slide upper.(follow an arrow).
 ※ **Caution**
 1) Be care of scratch and molding damage.

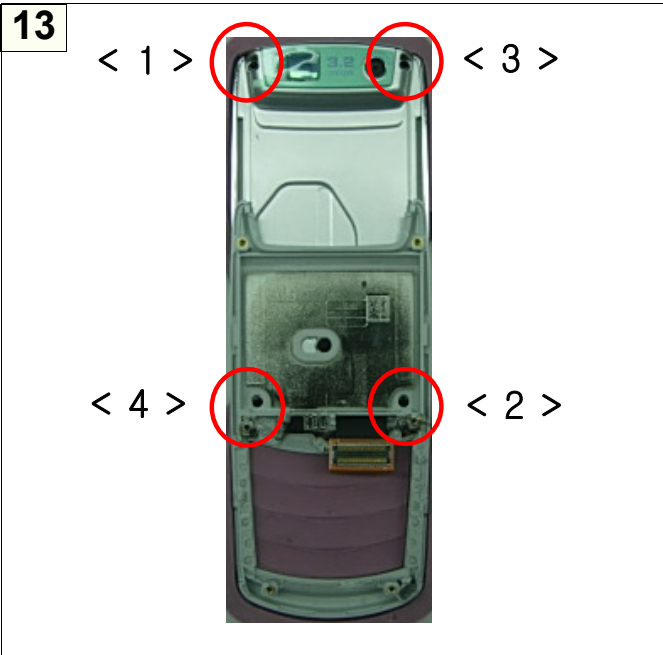

- 1) Screw down 4 points in the red circle.
*** Caution**
 1) Be care of scratch and molding damage.
 2) Screw down 4 points according to priority.

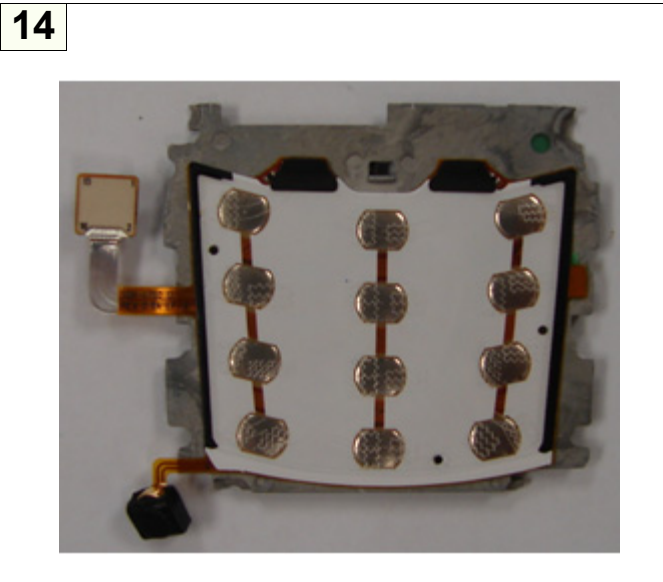

- 1) Attach the key-PCB on shield can.
*** Caution**
 1) Be care of damage to the F-PCBs.
 2) Please keep the three guide holes attaching key F-PCB.

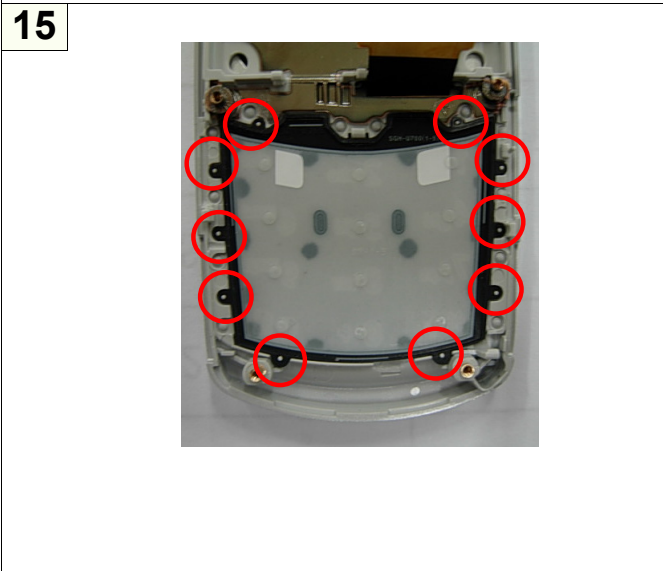

- 1) Assemble the keypad on the front.
*** Caution**
 1) Be care of scratch and molding damage.
 2) The 10 holes of keypad should be attached each pins.

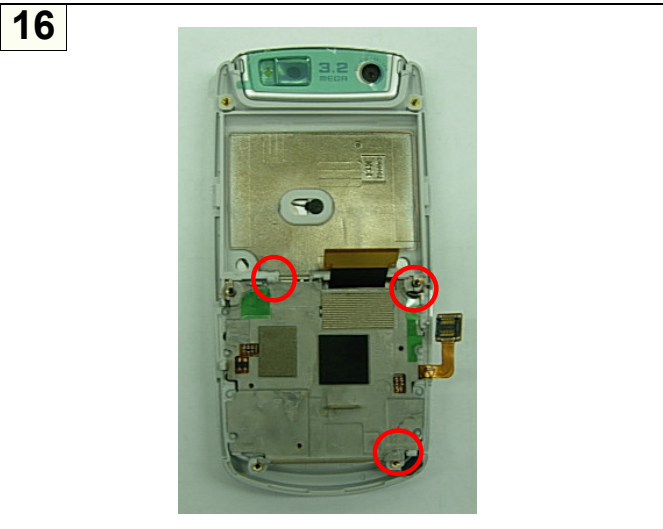

- 1) Assemble the shield can on the keypad.
*** Caution**
 1) Be care of scratch and molding damage.
 2) First, shield can of three circle should be attached.



- 1) Attach the tapes to the designated point.
 ※ **Caution**
 1) Be care of scratch and molding damage of the connectors..

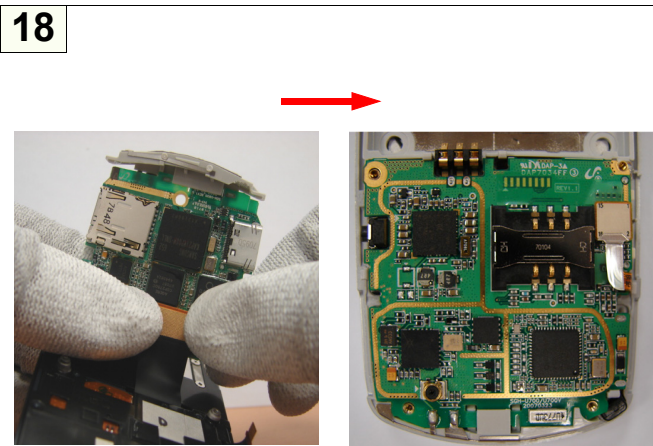

- 1) Assemble the PBA to the assembly.
 2) Assemble the key connector.
 ※ **Caution**
 1) Be care of scratch and molding damage.
 2) Be care of scratch and molding damage of the connector.

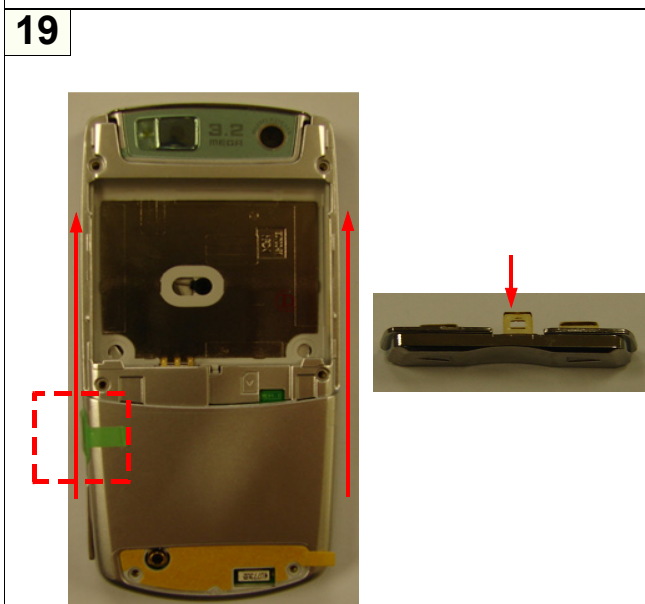

- 1) Check the camera key and volume key.
 2) Assemble the rear on slide assembly.
 ※ **Caution**
 1) Be care of scratch.
 2) Please follow arrows for easy assembly.

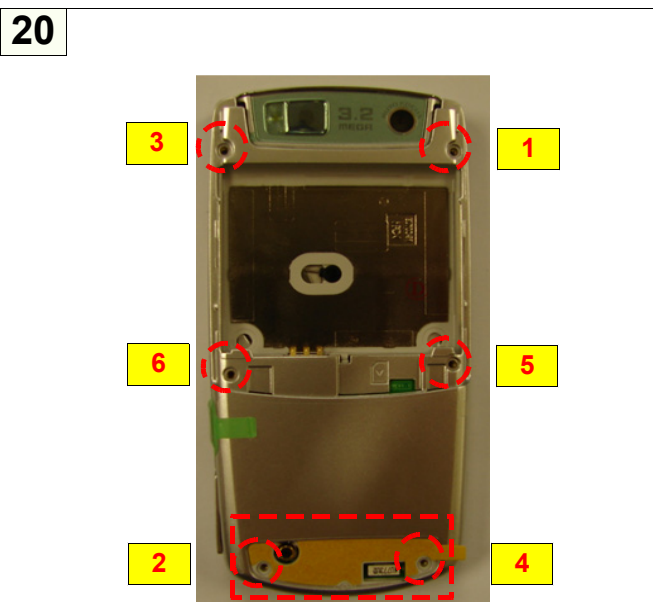

- 1) Screw down 6 points in the red circle.
 2) Attach RF sheet to the designated points.
 ※ **Caution**
 1) Be care of scratch and molding damage.
 2) Screw down 6 points according to priority.

3. Flow Chart of Troubleshooting

3-1. Baseband

3-1-1. Power ON

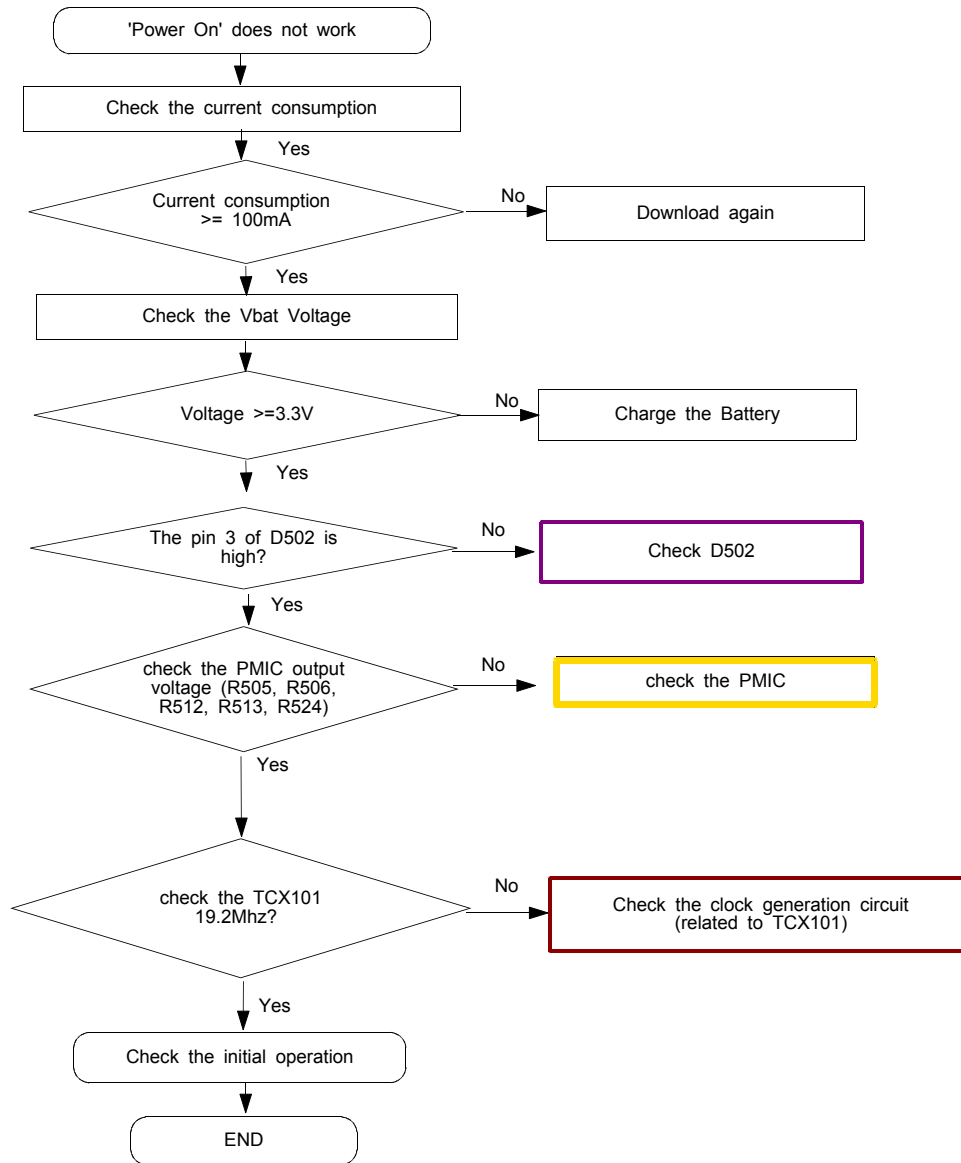

Flow Chart of Troubleshooting

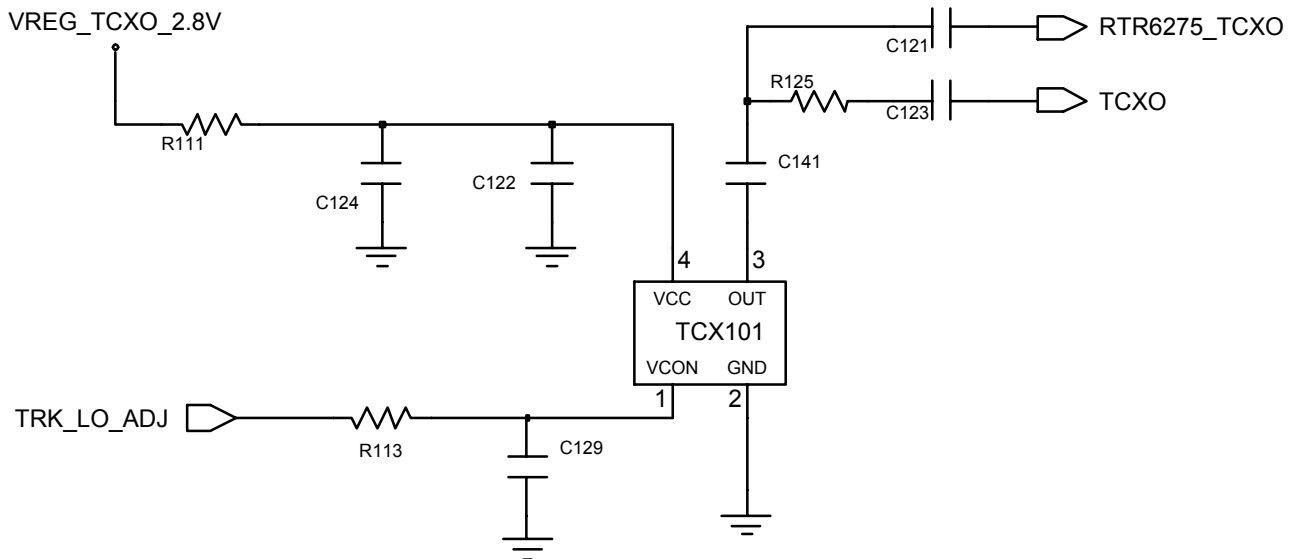
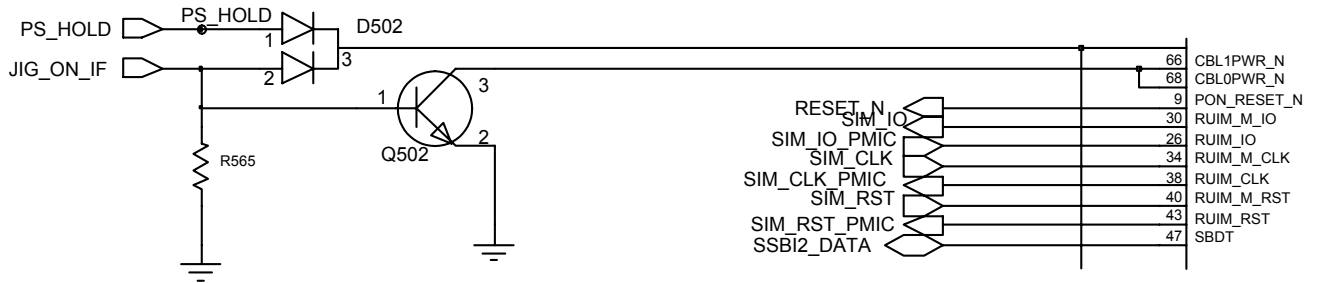
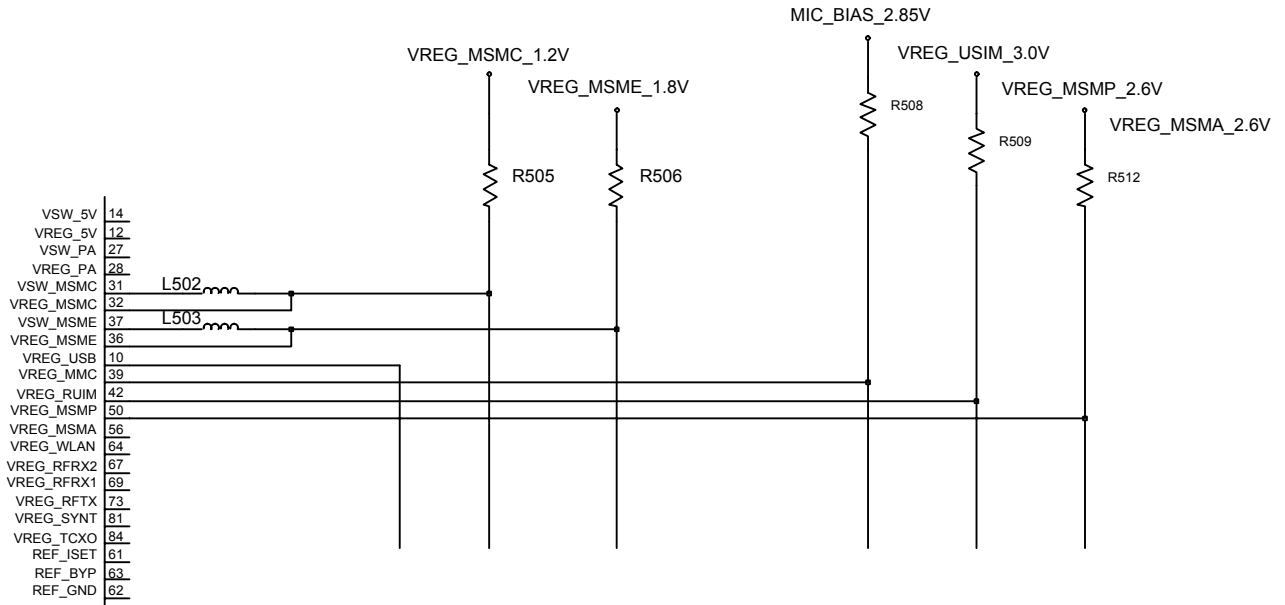

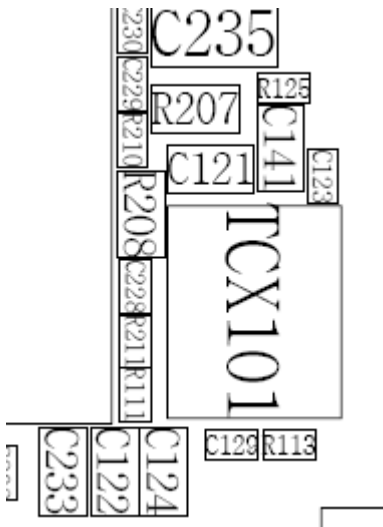

3-1-2. Initial

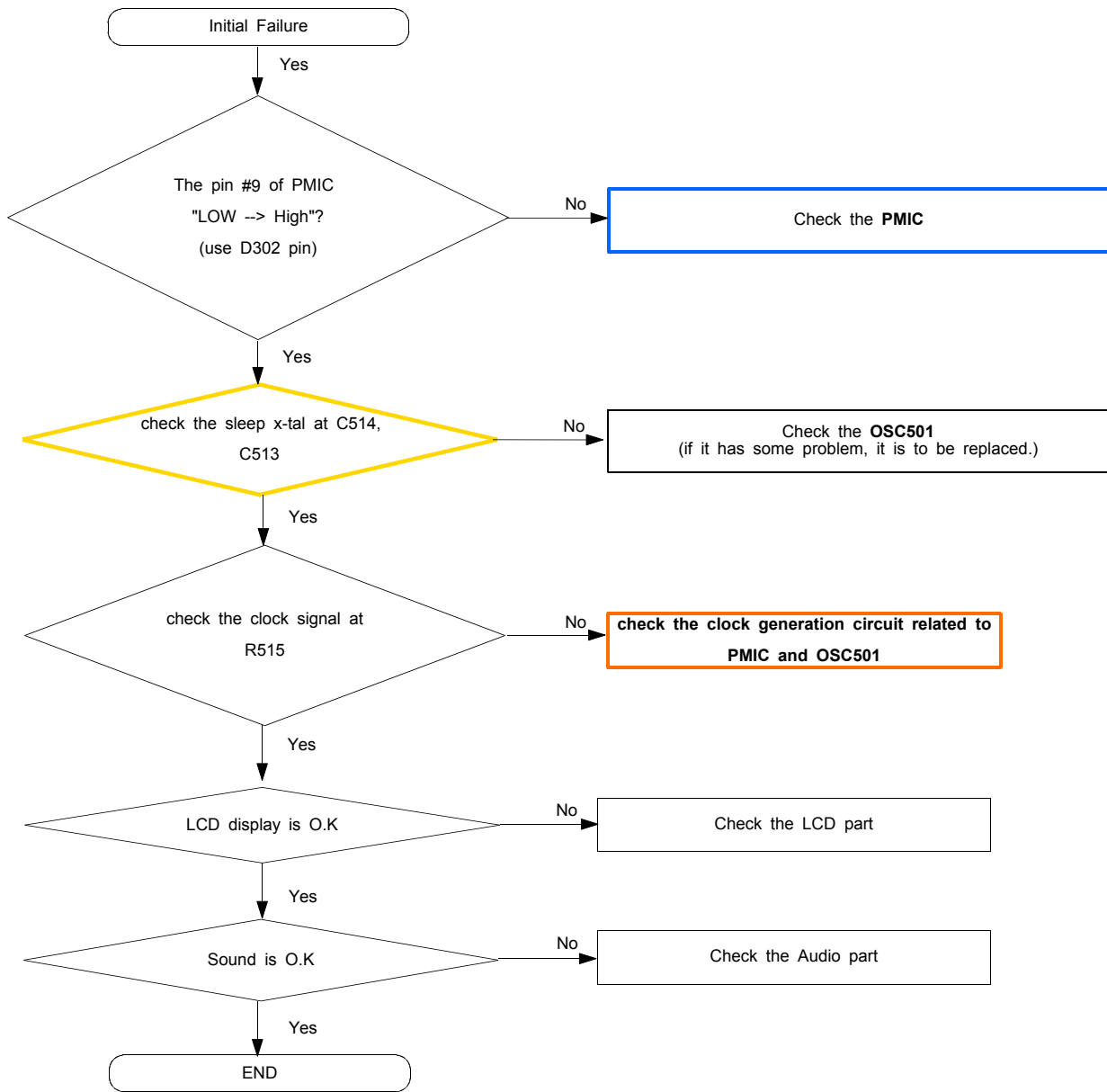

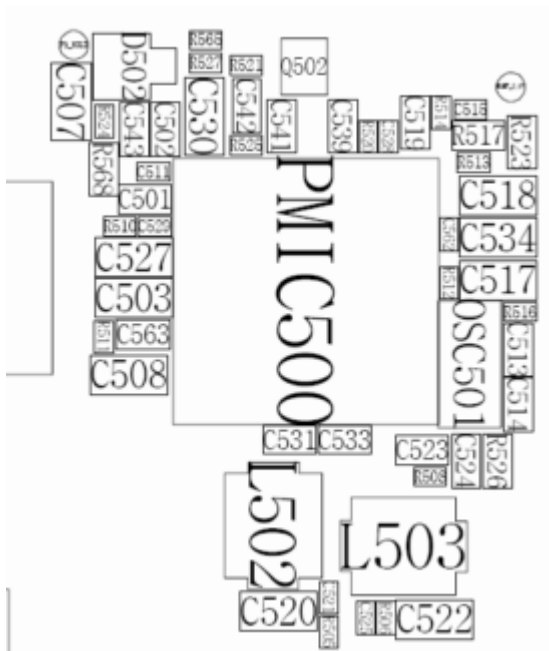
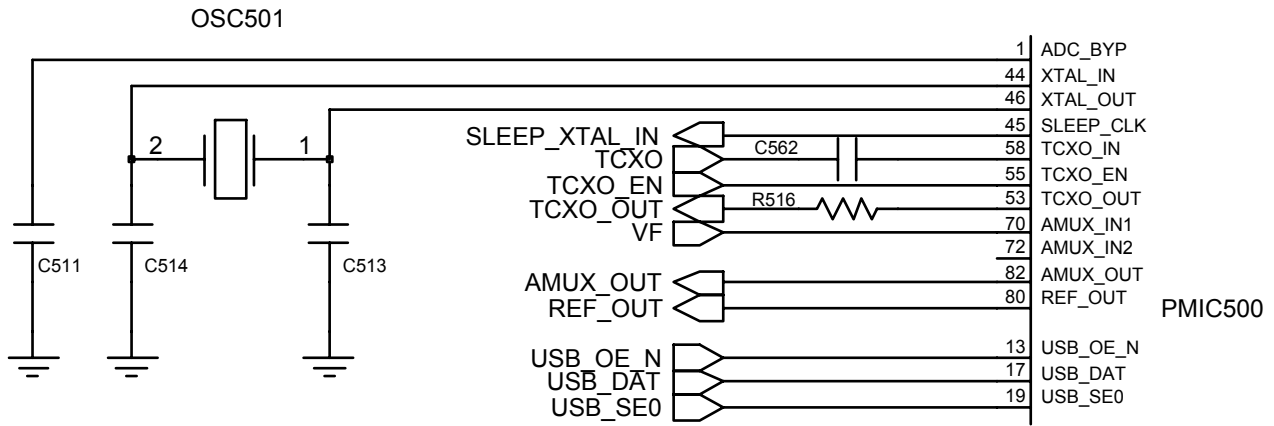

3-1-3. Sim Part

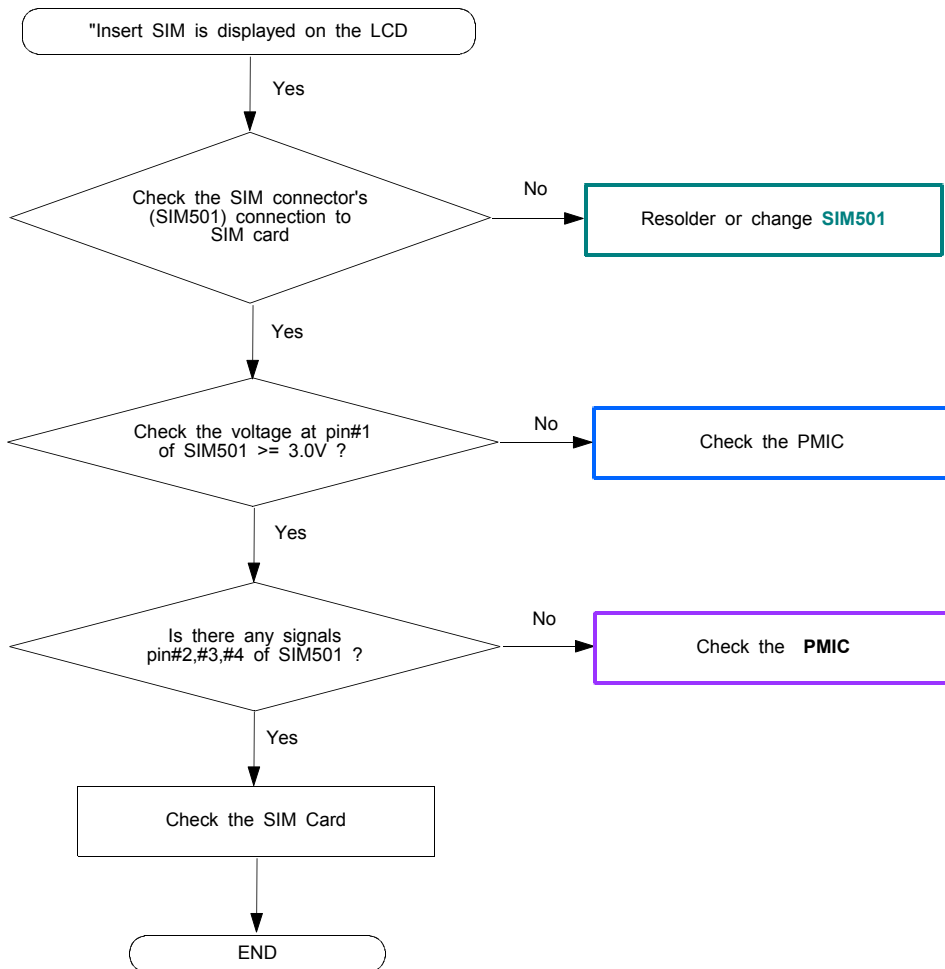

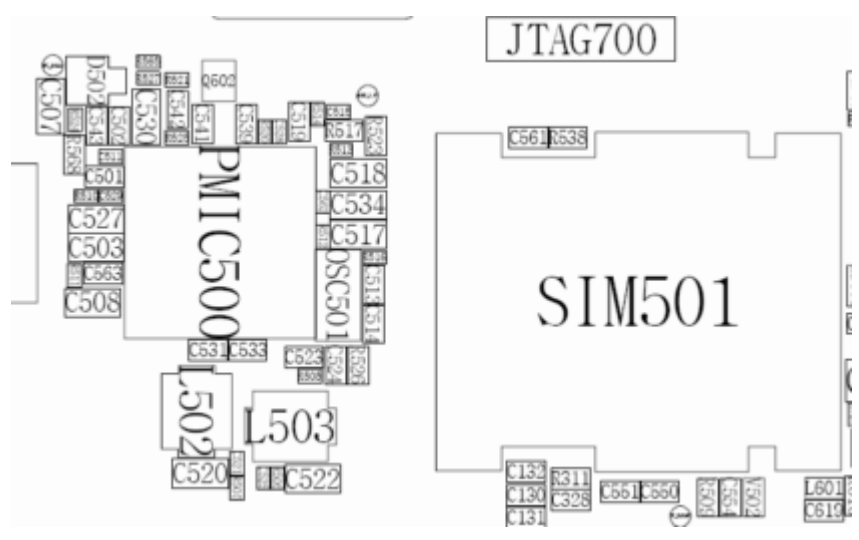
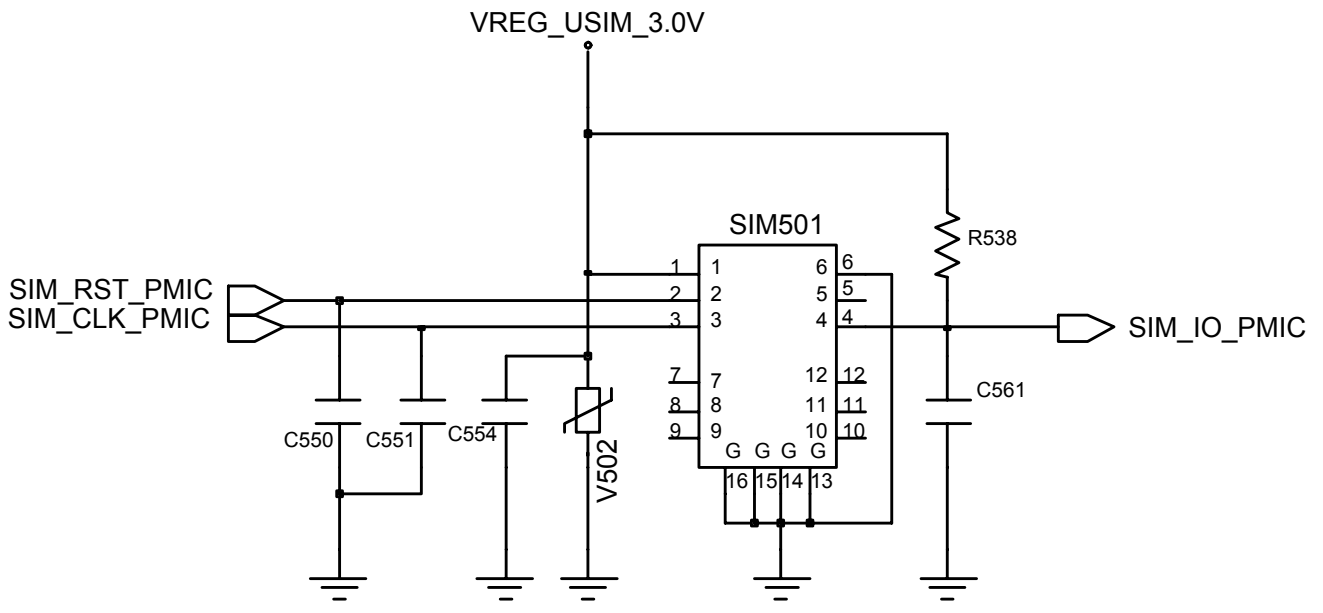

3-1-4. Microphone Part

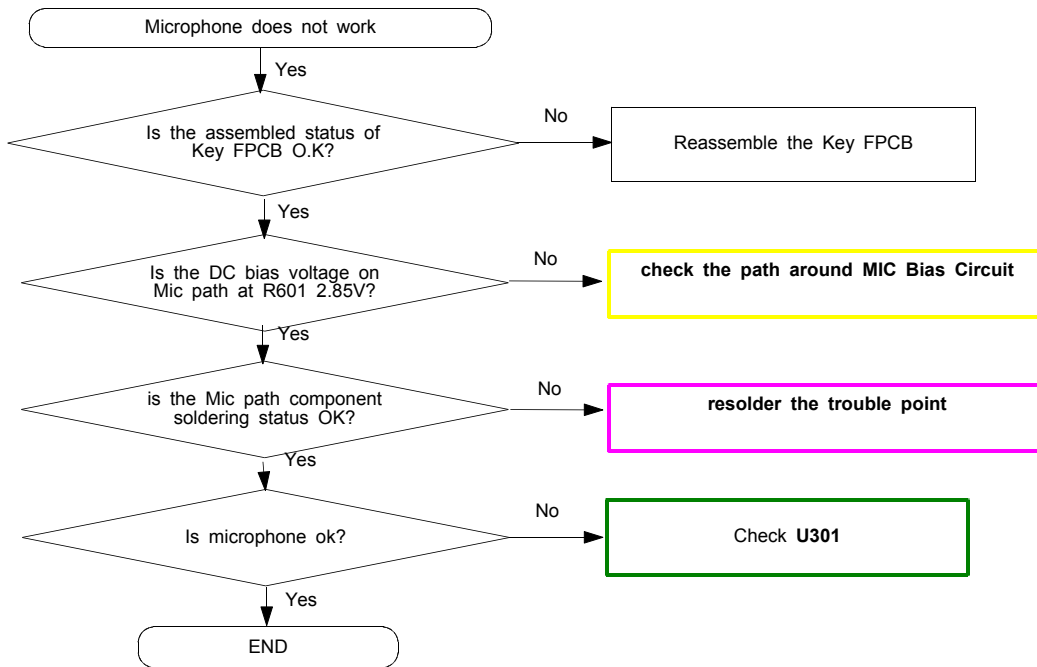

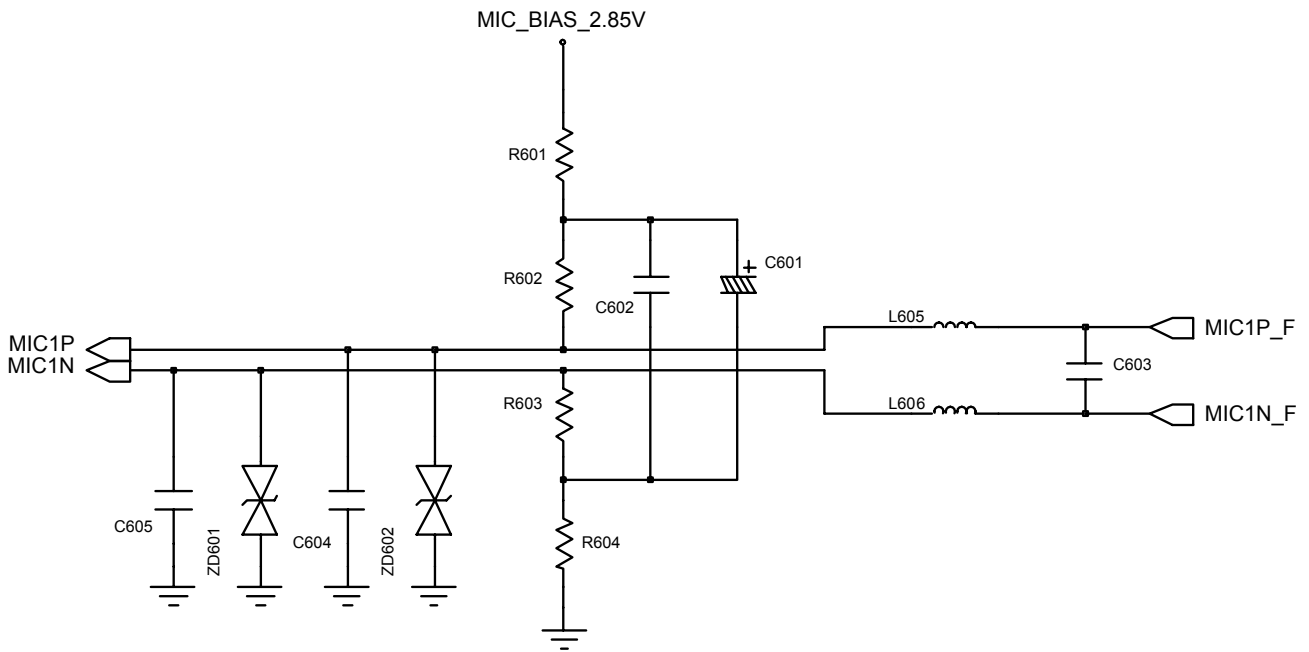
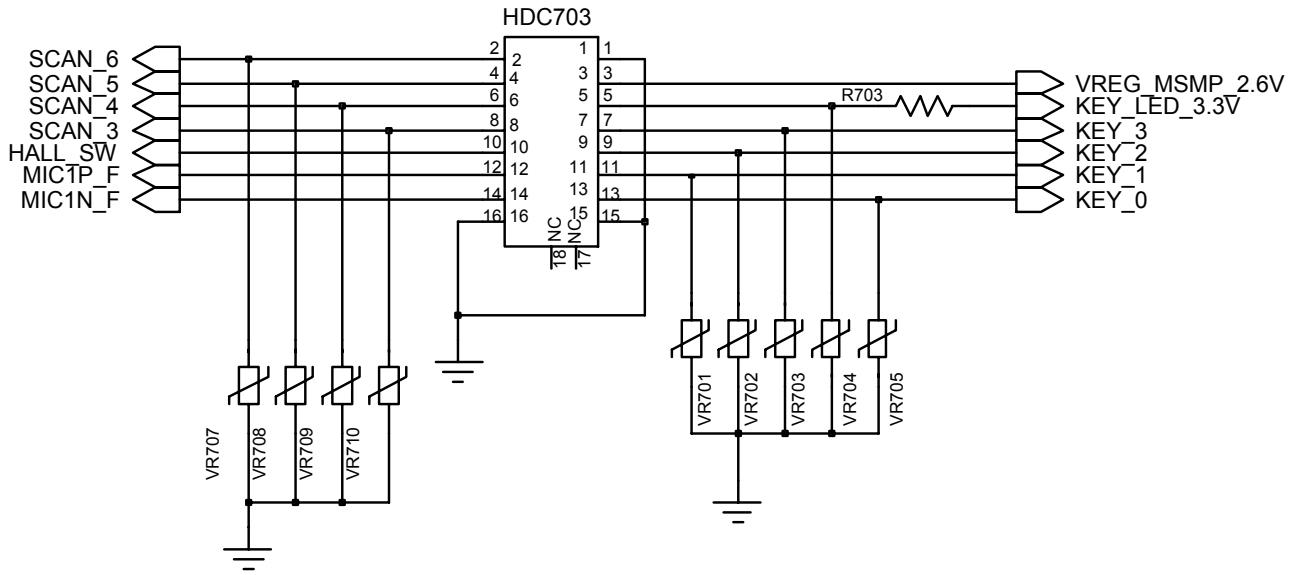

3-1-5. Speaker Part

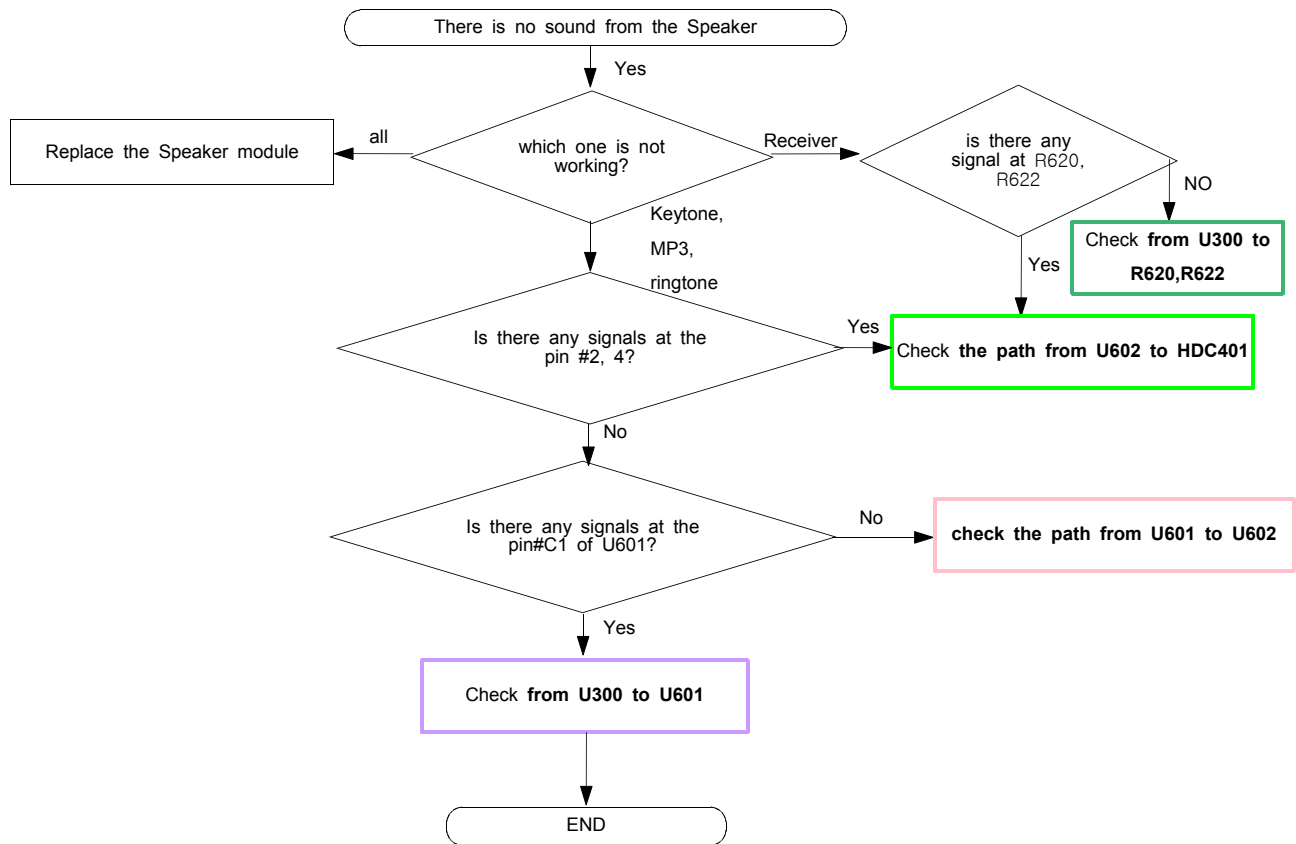

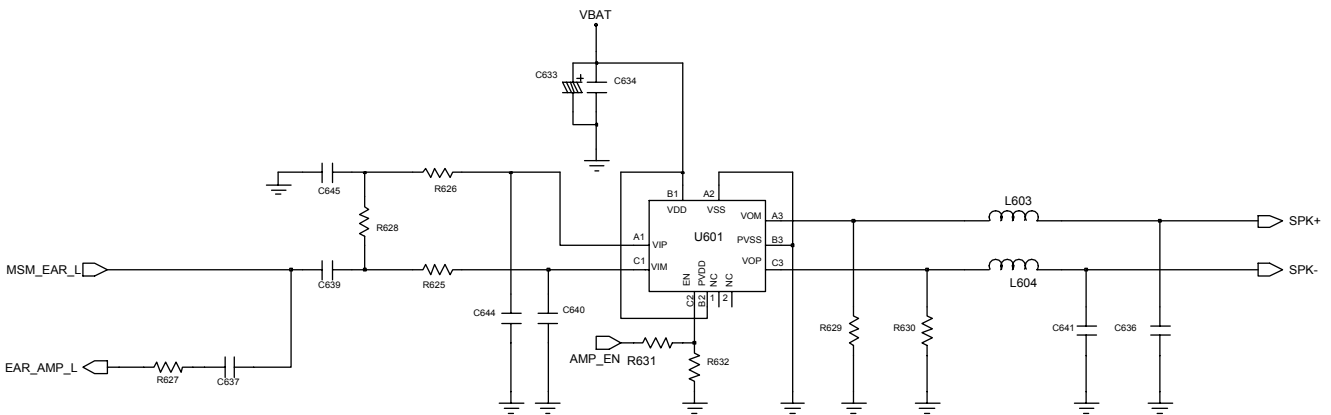
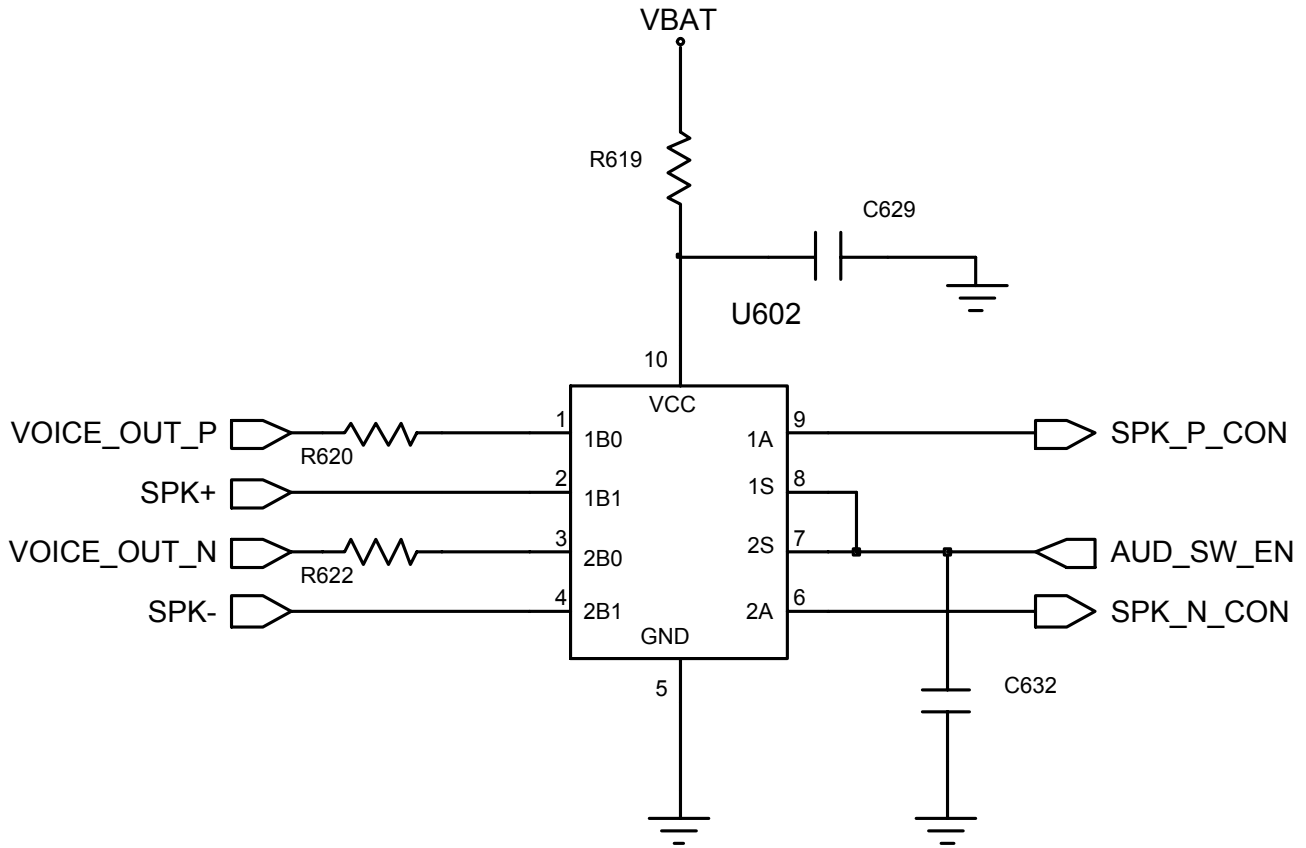

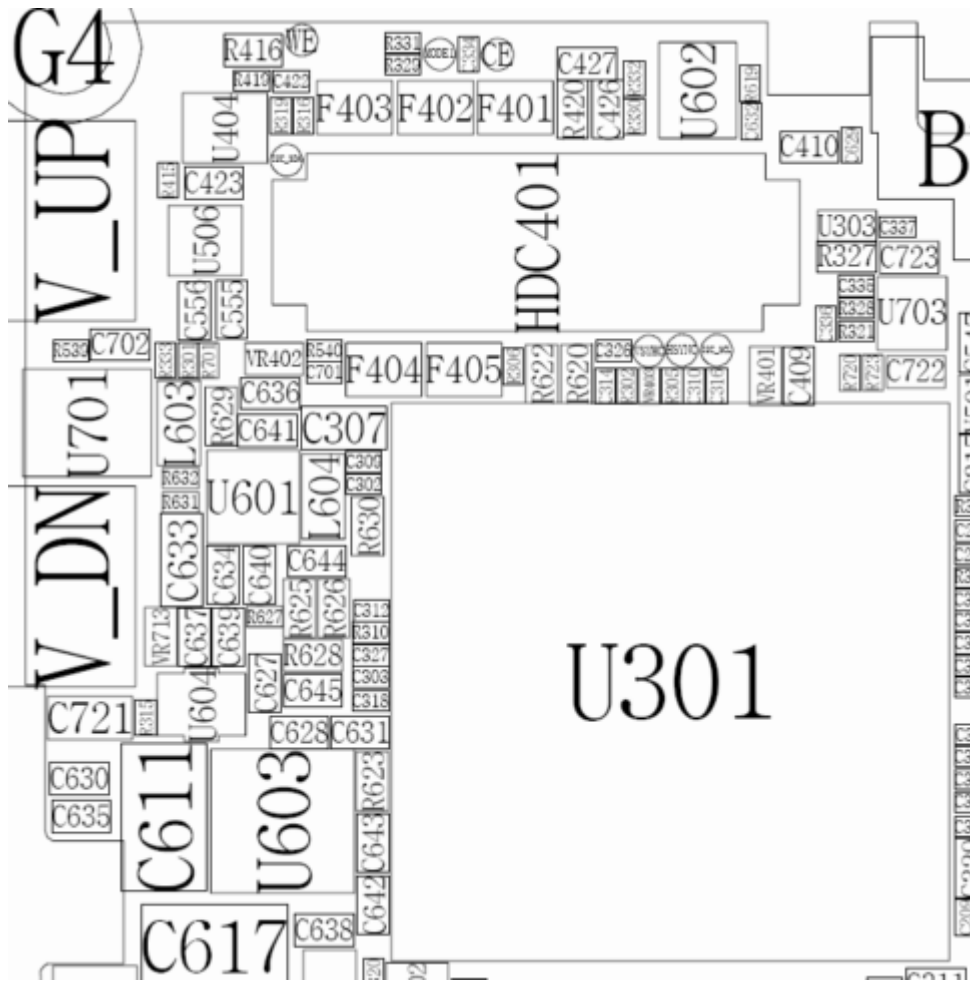

3-2.RF
3-2-1. EGSM Rx

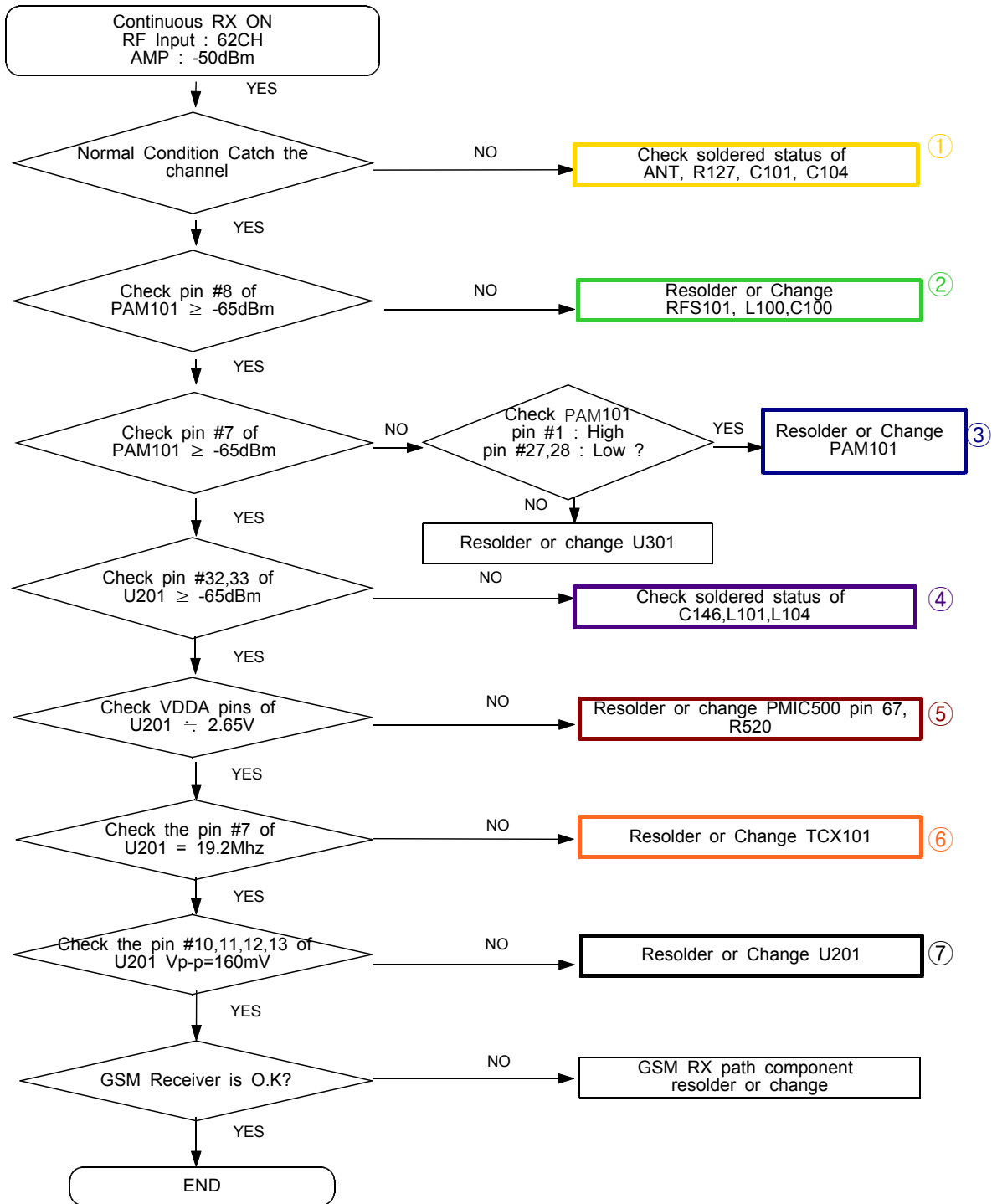

3-2-2. DCS Rx

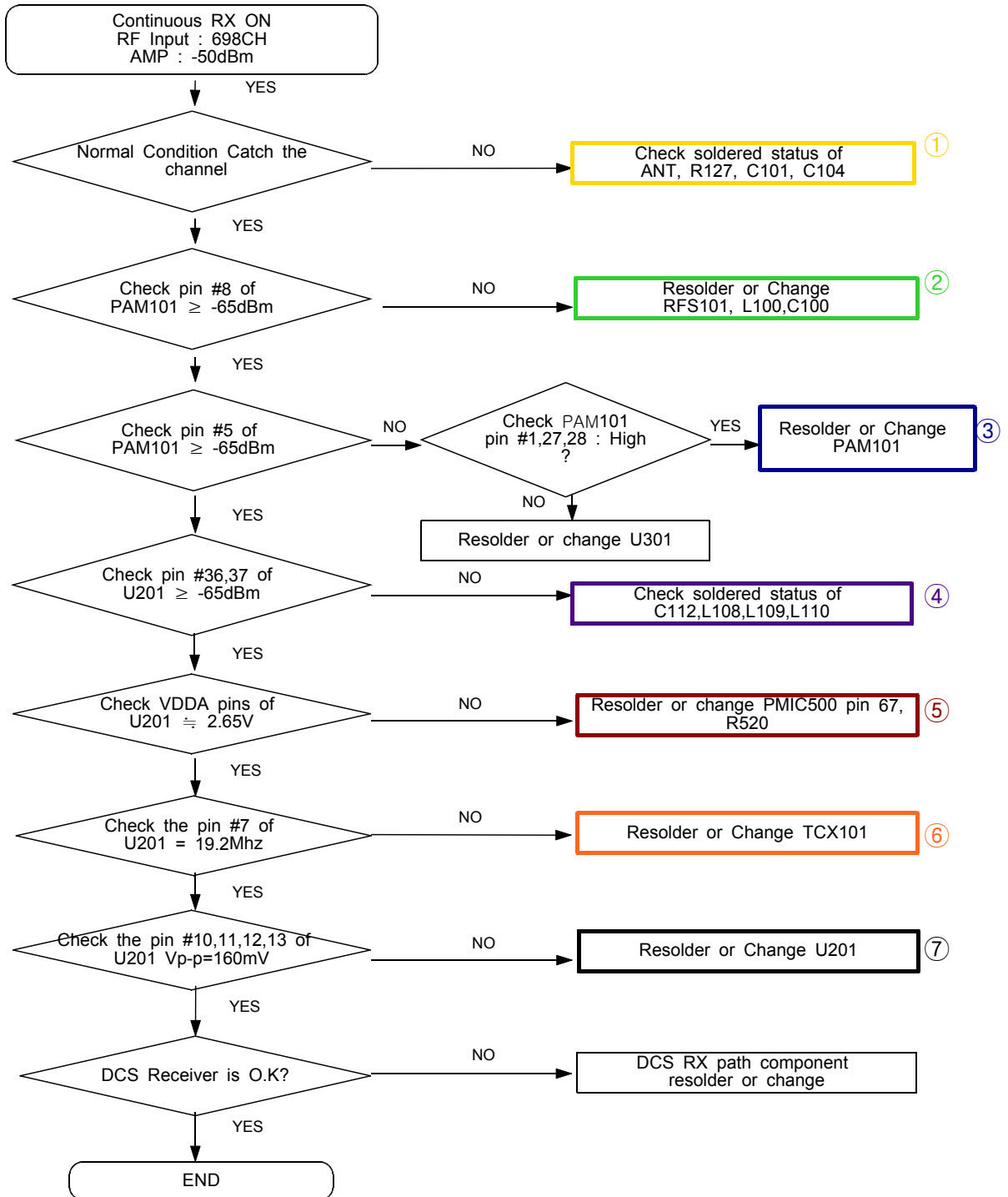

3-2-3. PCS Rx

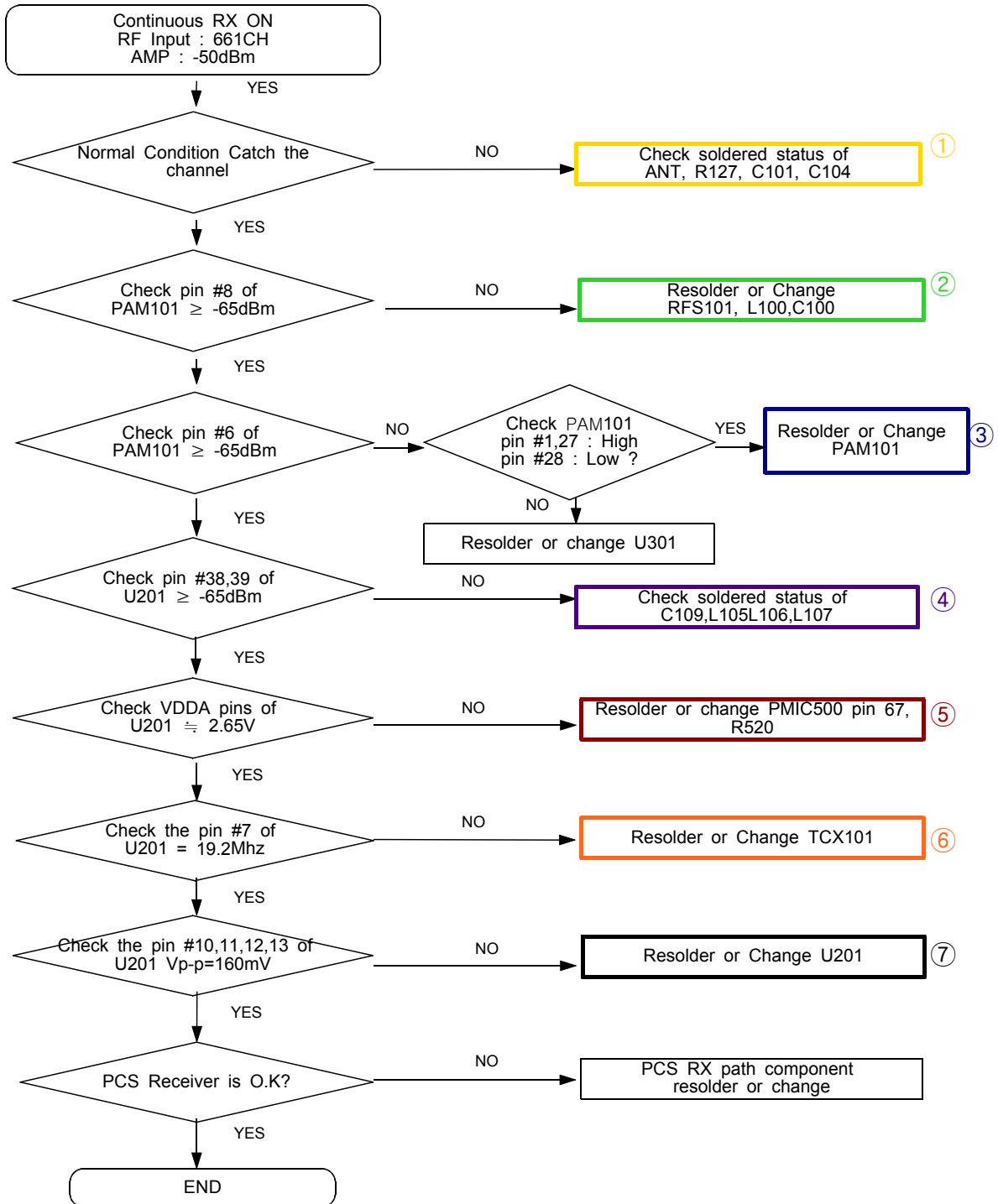

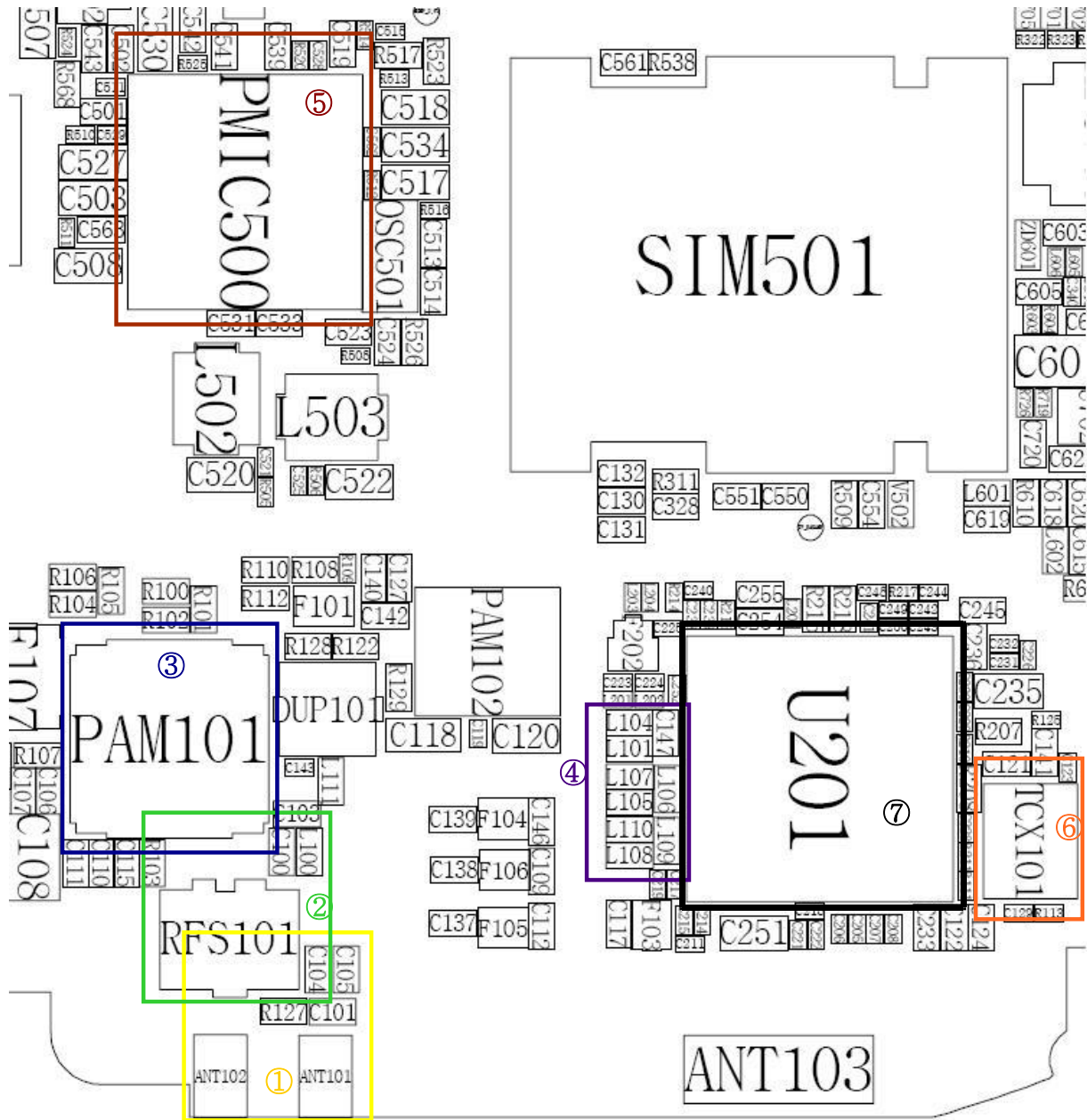

3-2-4. GSM Tx

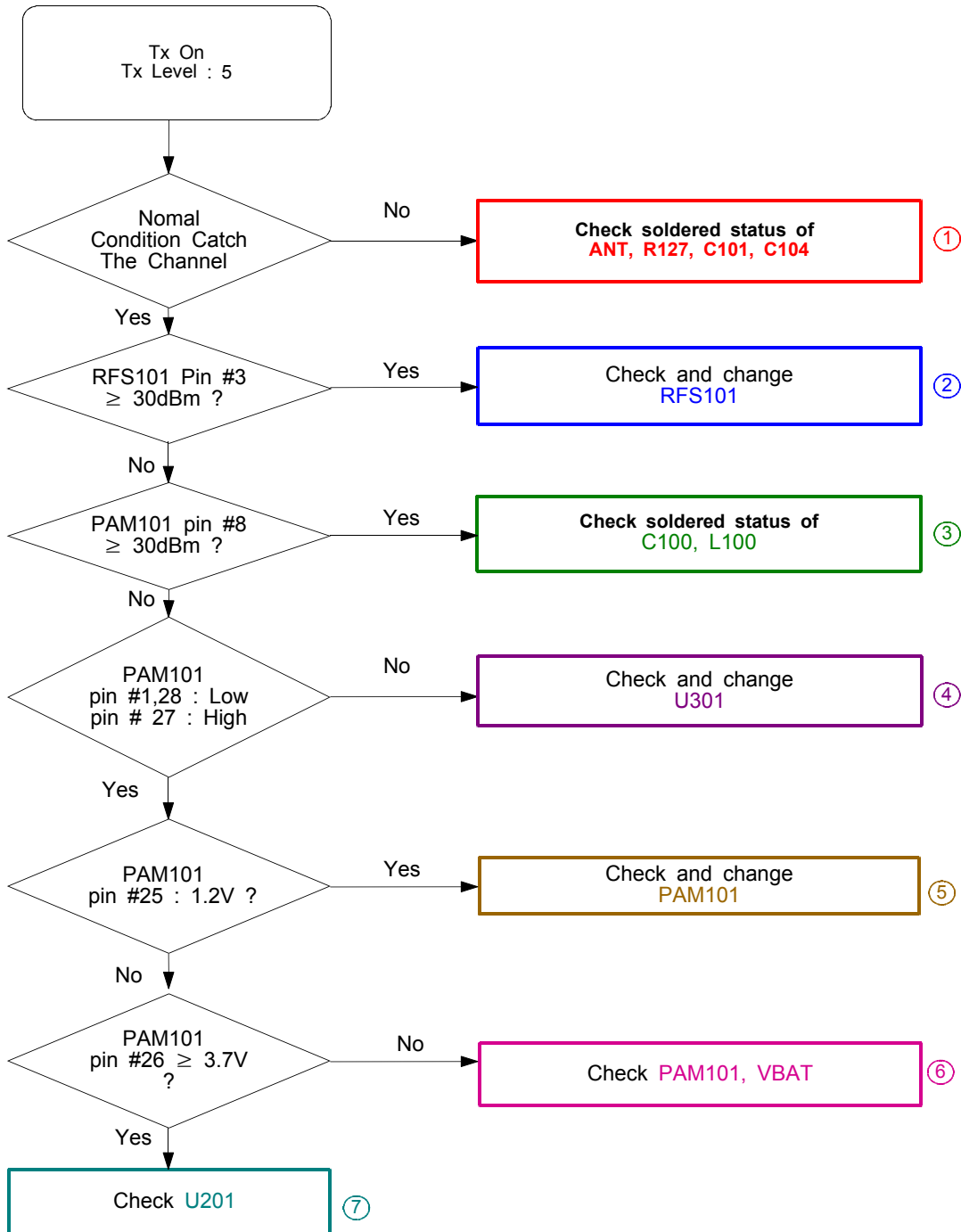

3-2-5. DCS Tx

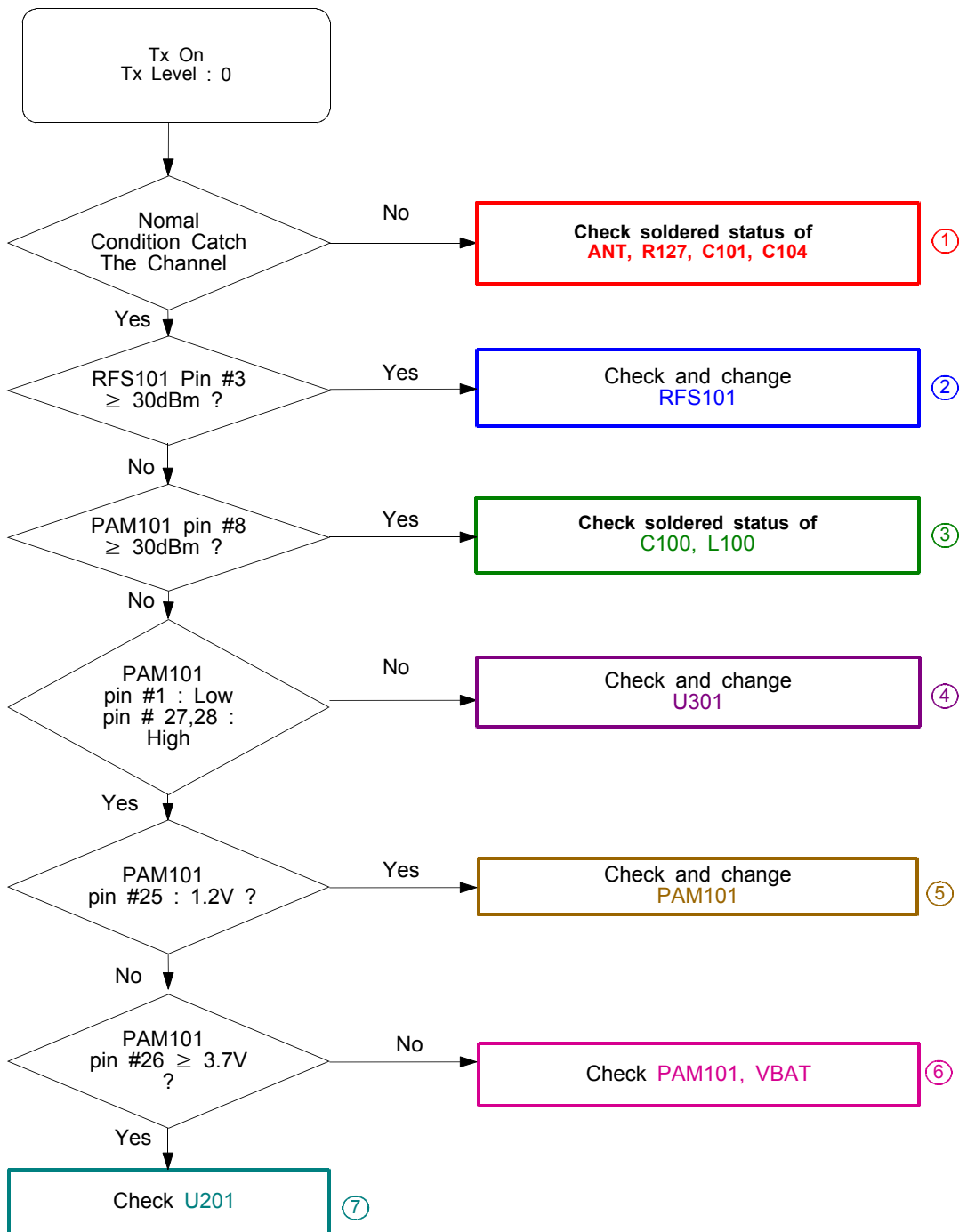

3-2-6. PCS Tx

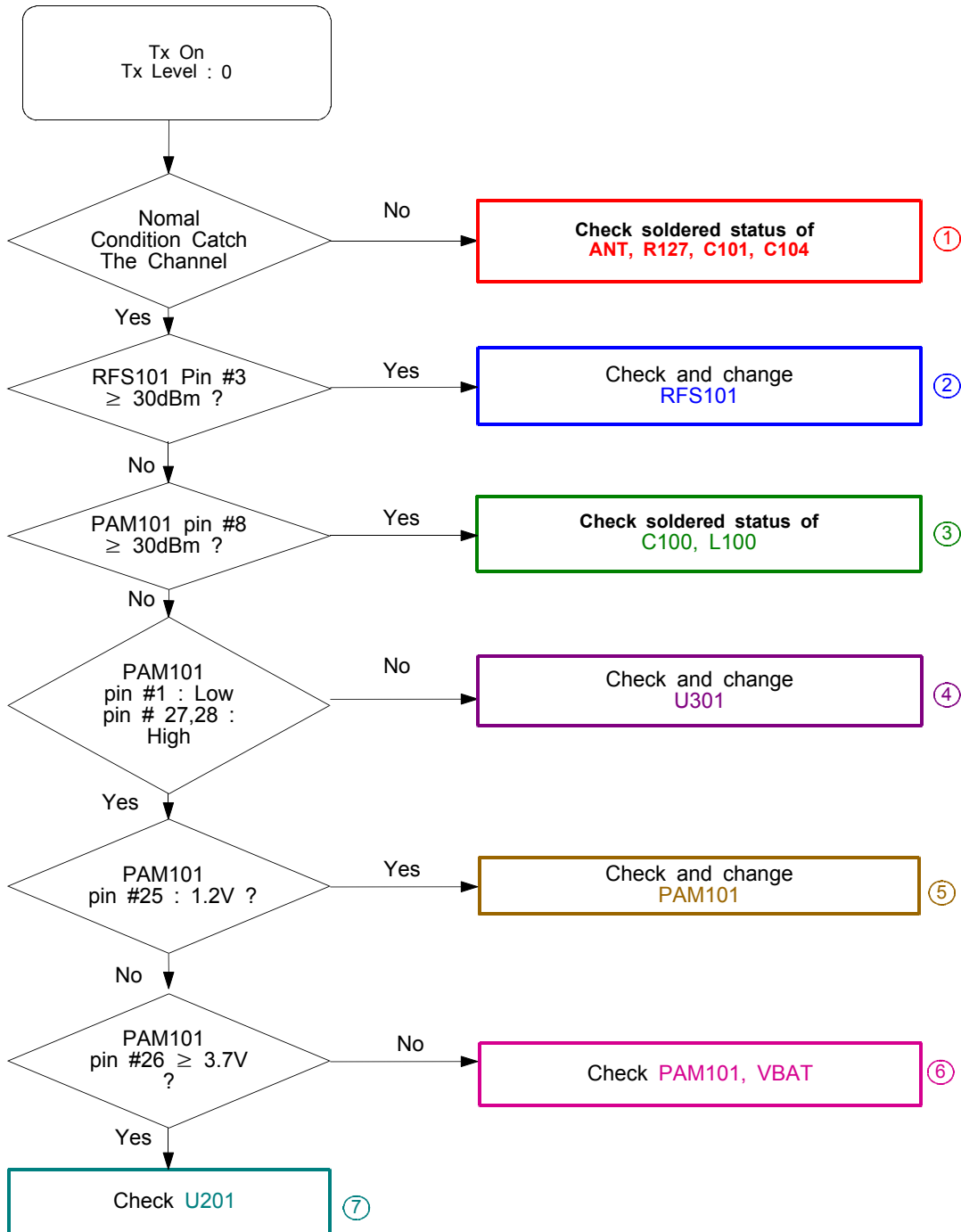

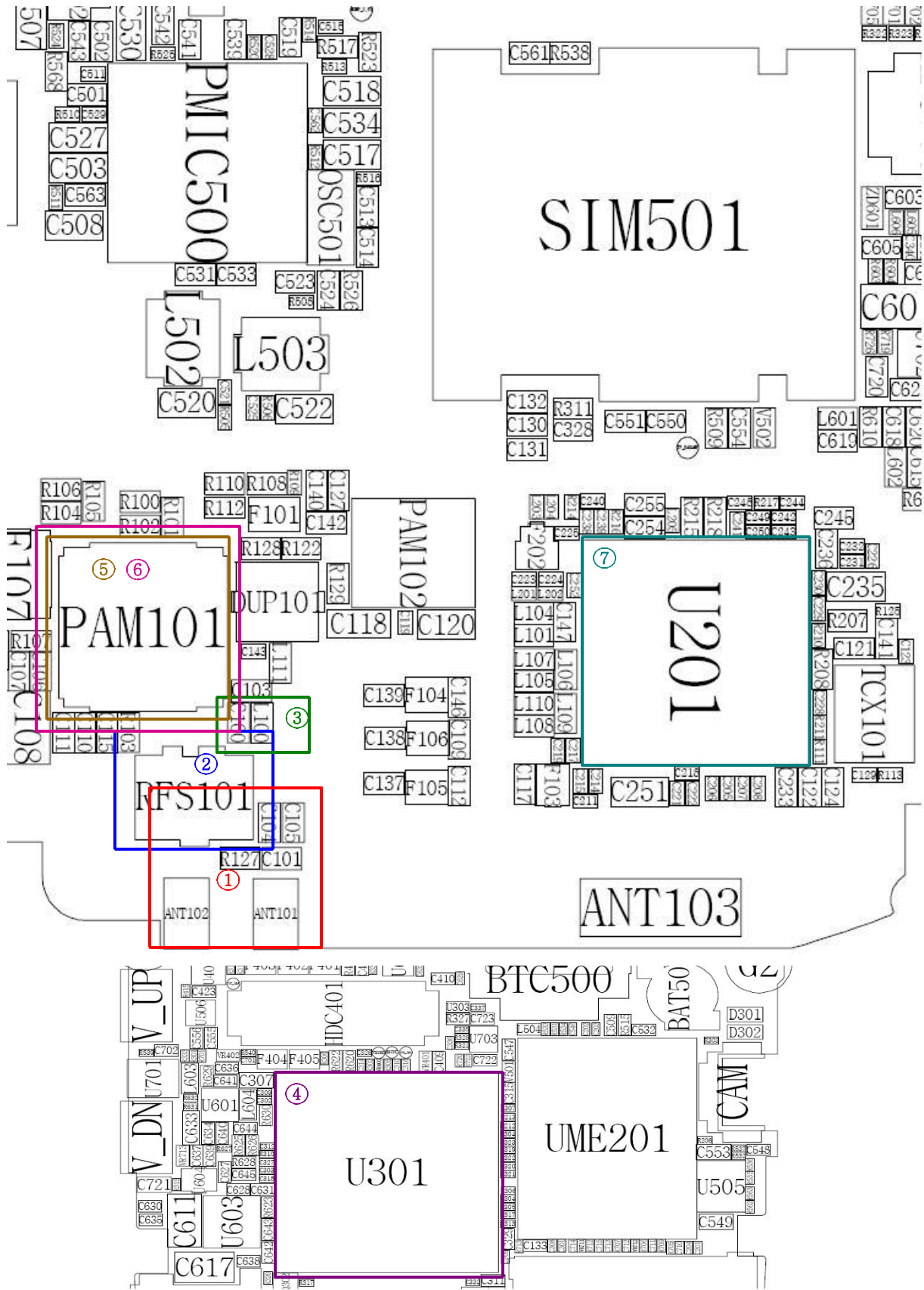

3-2-7. UMTS Rx

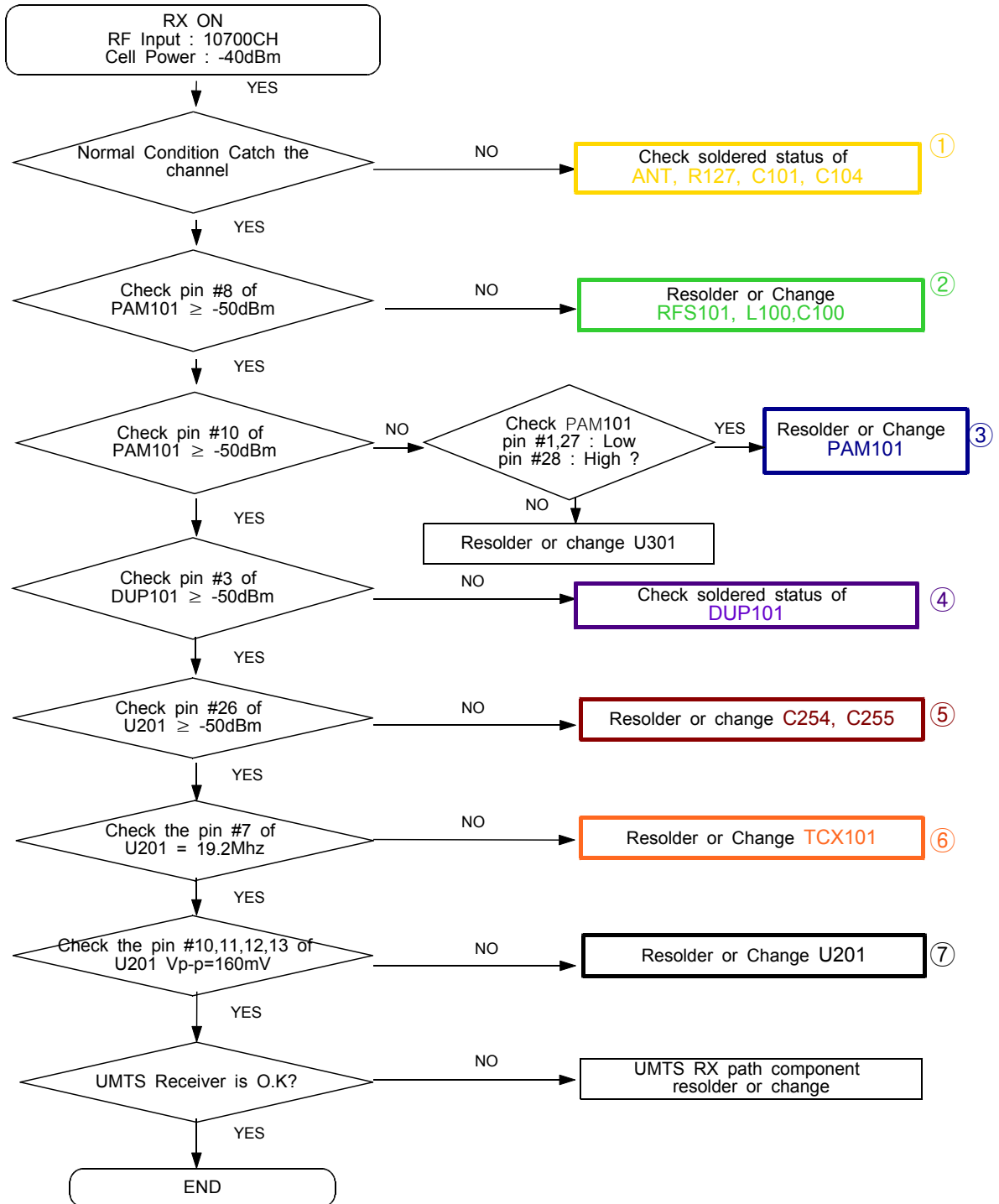

3-2-8. UMTS Tx

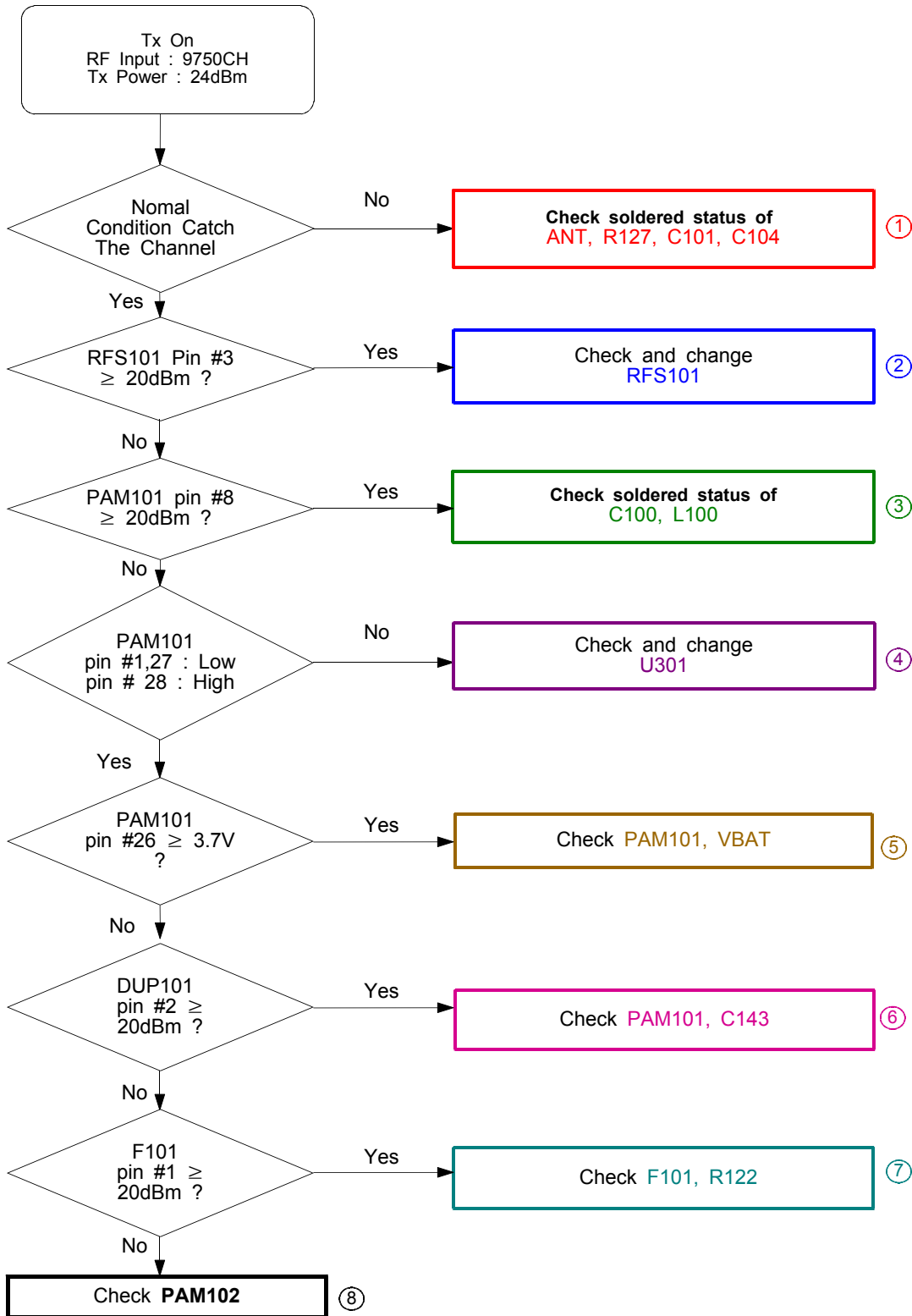

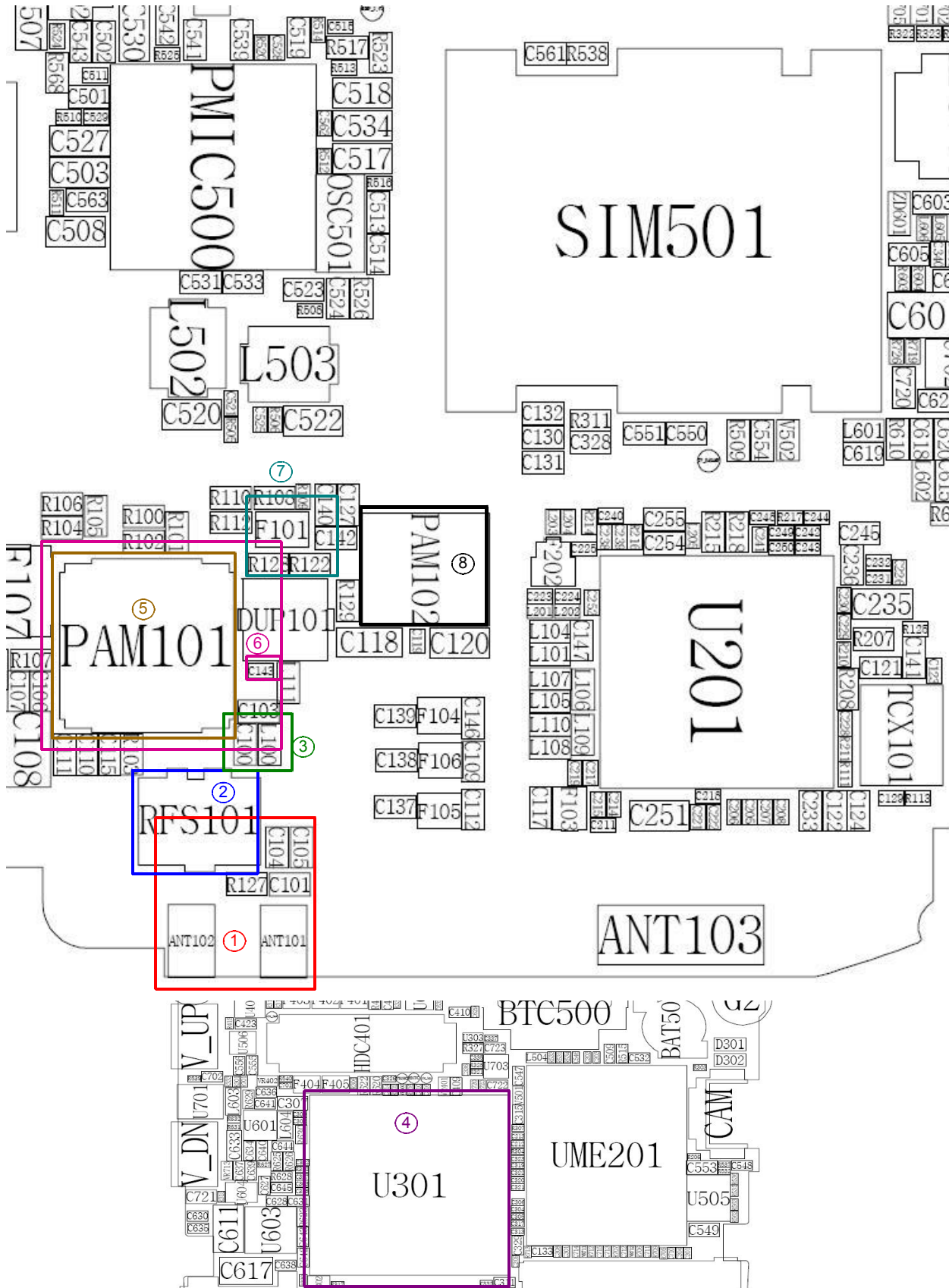

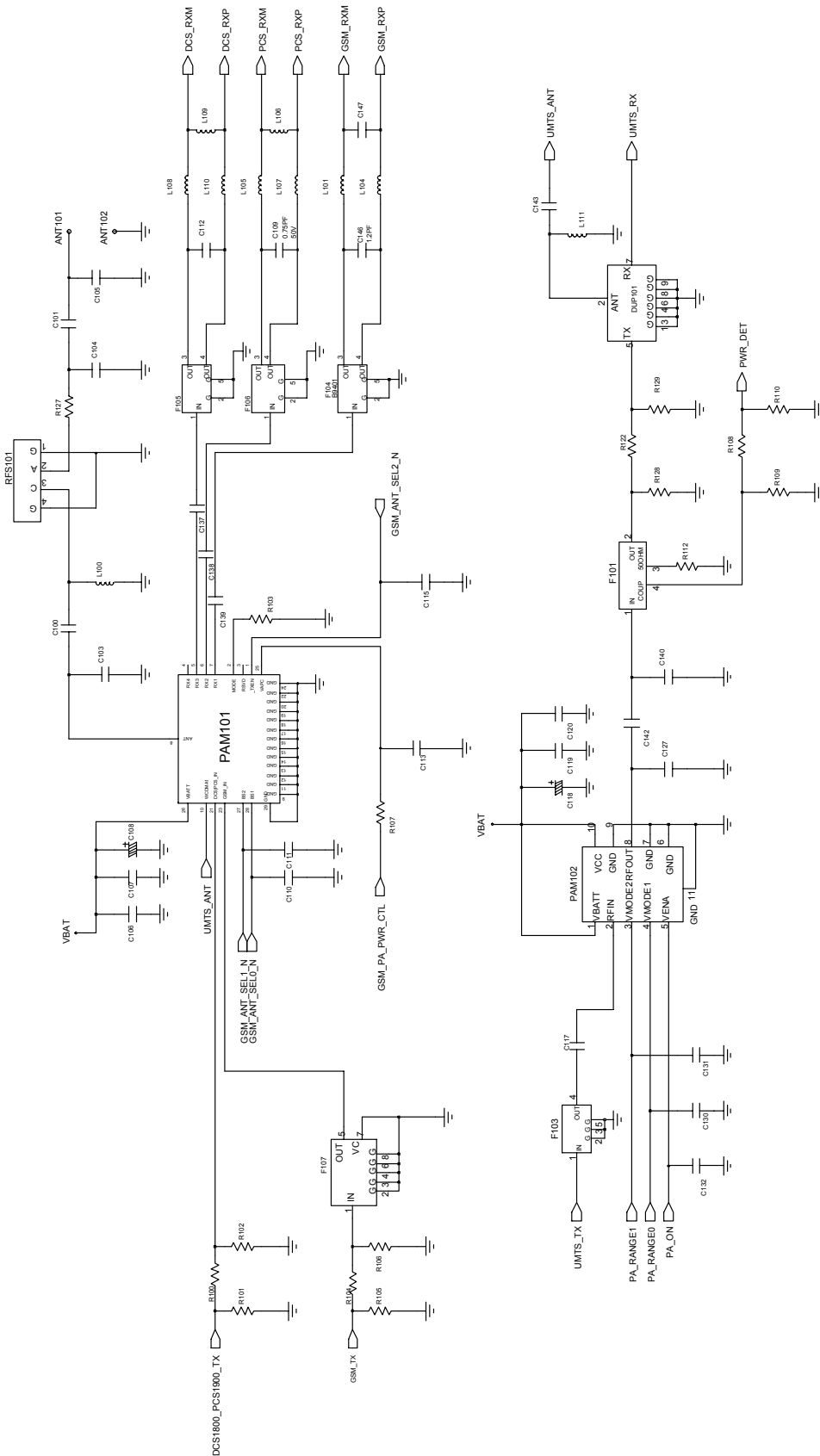

4. Array course control



Test Jig (GH80-03308A)



Test Cable (GH39-00509A)



RF Test Cable (GH39-00397A)

Software Downloading

4-1. Downloading Binary Files

- BOOTFILES folder and four binary files for downloading U700.
 - BOOTFILES : Directory of boot files.
 - amss_compressed.bin : Main source code binary.
 - Rsrc_U700_xxx.rc1 : Resource 1.
 - Rsrc2_U700xxx(Low).rc2 : Resource 2.
 - FactoryFs_U700_xxx.ffs

4-2. Pre-requisite for Downloading

- Downloader Program([MultiLoader xxx.exe](#))
- U700 Mobile Phone
- Data Cable
- Binary files

4-3. S/W Downloader Program

1. Load the binary download program by executing the **"MultiLoader xxx.exe"**
2. Click the **"MSM6245/MSM6260"**

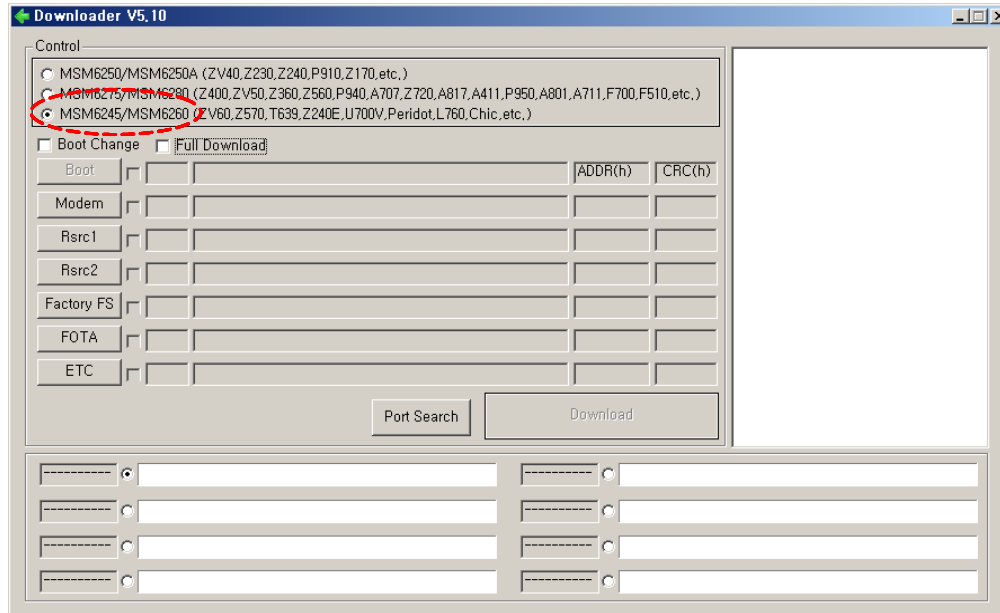

3. Click the **"Full Download" -> "Boot"**

Set the directory path and choose latest BOOTFILES folder for the downloader binary setting.

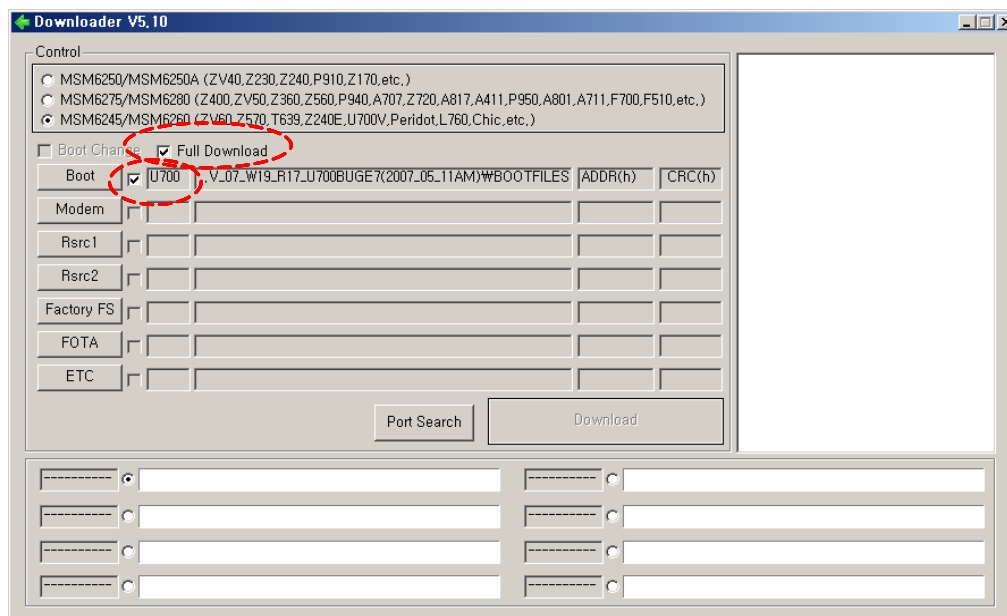

4. Press the **"Modem" -> "amss_compressed.bin"**

Set the directory path and choose latest amss_compressed.bin file for the downloader binary setting.

5. Press the **“Rsrc1”** -> **“Rsrc_U700_xxx.rc1”**
Set the directory path and choose latest Rsrc_U700_xxx.rc1 file for the downloader binary setting.
6. Press the **“Rsrc2”** -> **“Rsrc2_U700xxx(Low).rc2”**
Set the directory path and choose latest Rsrc2_U700xxx(Low).rc2 file for the downloader binary setting.
7. Press the **“Factory FS”** -> **“FactoryFs_U700_xxx.ffs”**
Set the directory path and choose latest FactoryFs_U700_xxx.ffs file for the downloader binary setting.
8. Press the **Port Search** when the download cable is connected.
(Before connecting the cable at U700 Mobile phone, push the ‘9’ and ‘PWR KEY’ at the same time.)
9. Press **Download** If you can detect the port(s). (Up to eight ports are supported.)

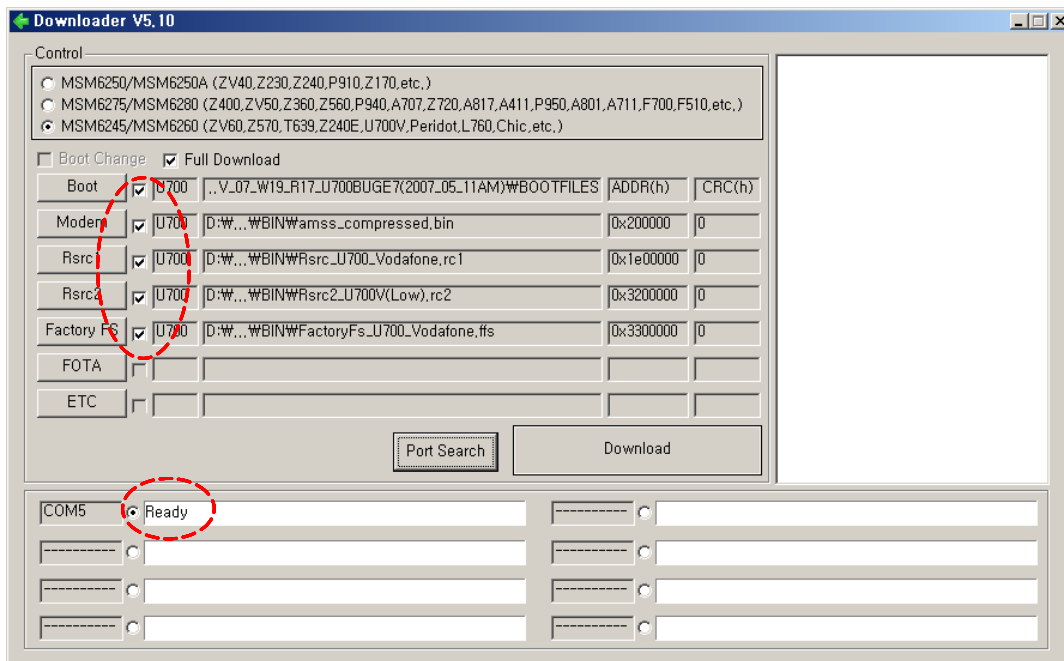

※ When you select these files&folder you have to confirm the directory whether correct directory or not.

10. When downloading is finished successfully, there is a “All files complete” message and each port panel shows texts that "Ready".

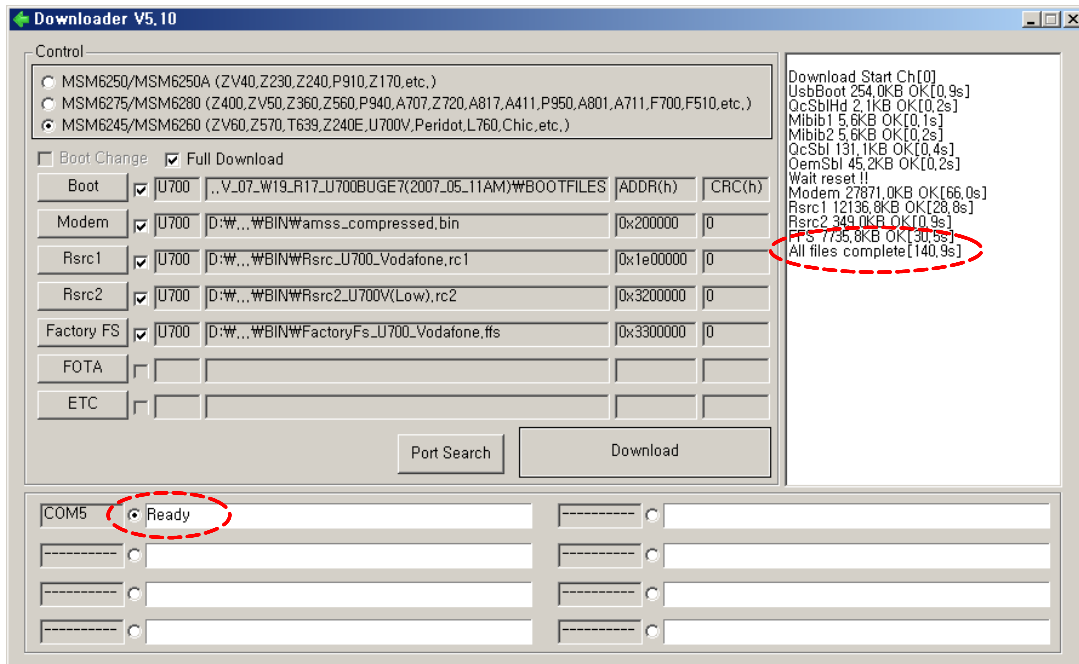

11. Confirm the downloaded version name and etc. :

***#1234#**

Full Reset :

***2767*3855#**

5. Block Diagrams

5-1. Base Band Block Diagram

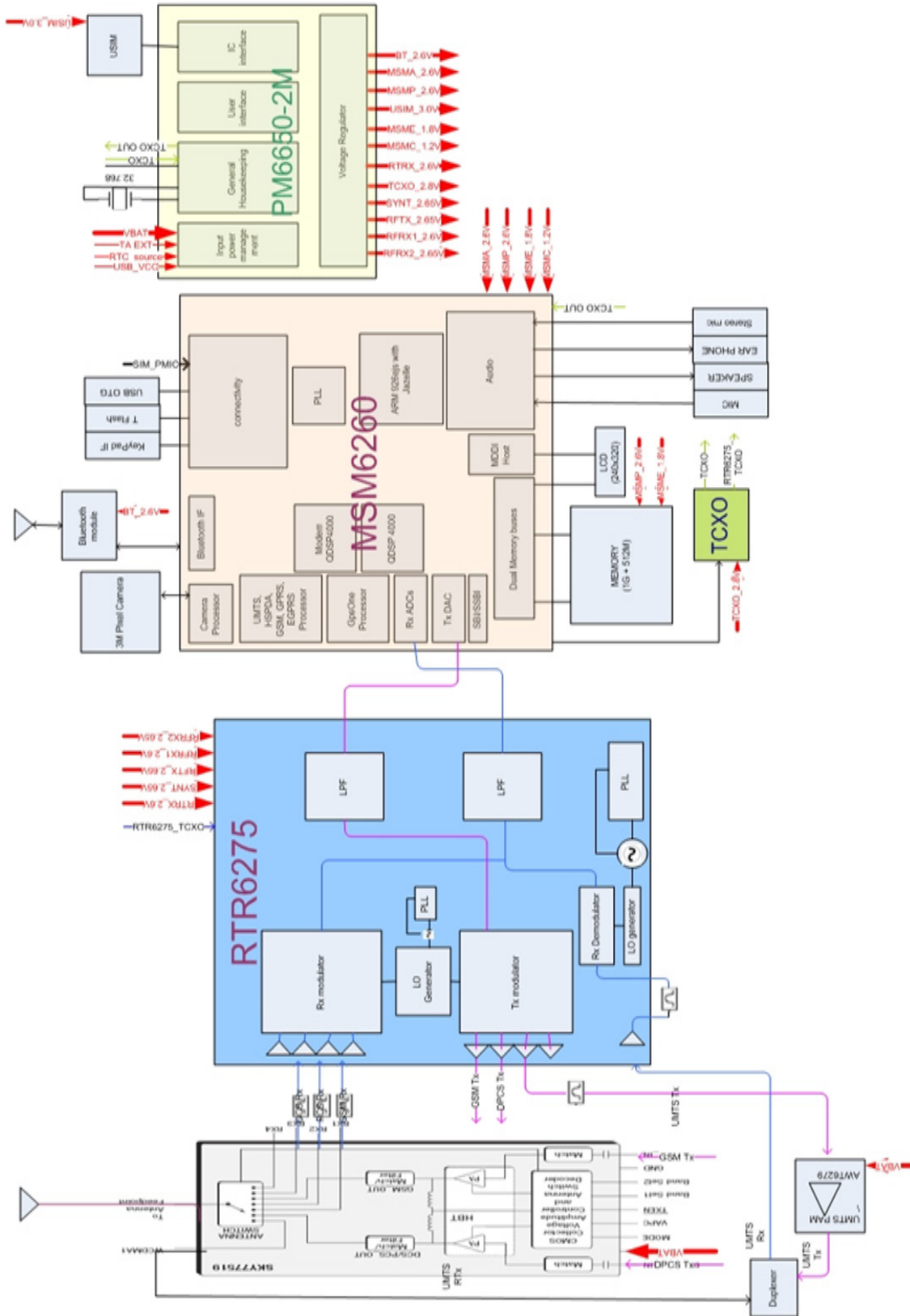

6. PCB Diagrams

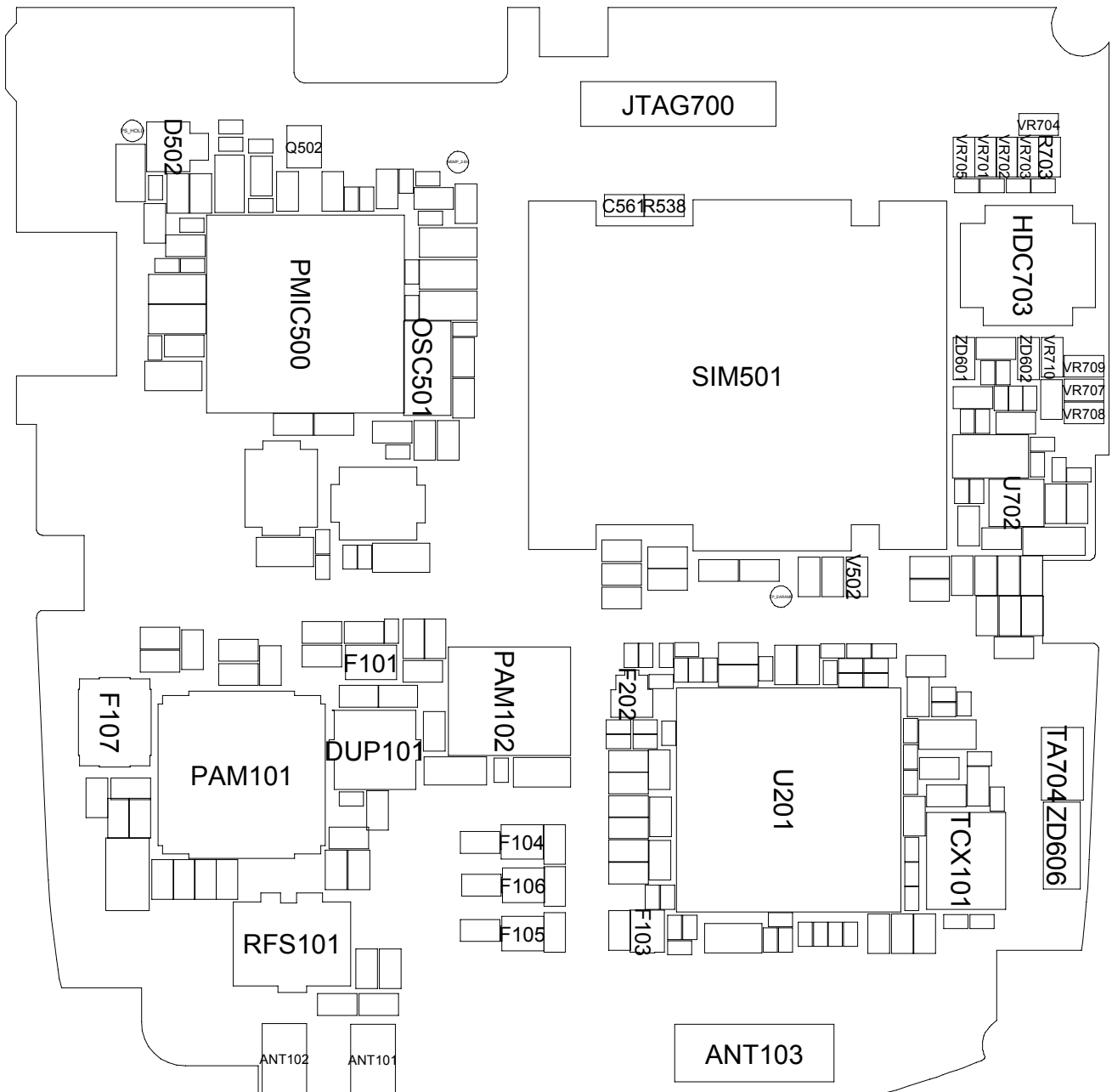

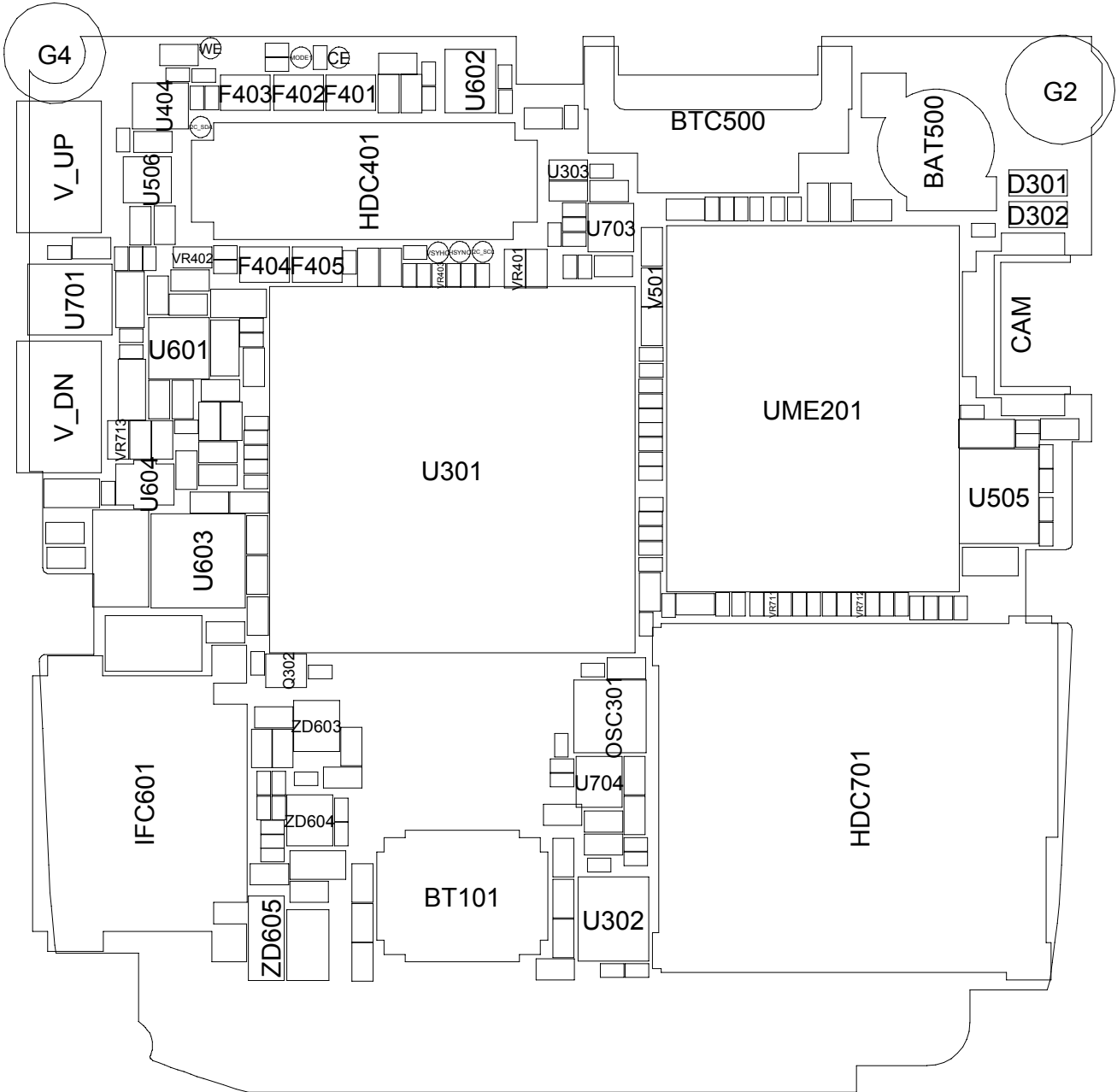
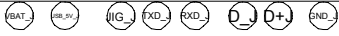

7. MAIN Electrical Parts List

SEC CODE	Design LOC	Discription	STATUS
0403-001547	ZD605	DIODE-ZENER	SA
0403-001547	ZD606	DIODE-ZENER	SA
0404-001172	D301	DIODE-SCHOTTKY	SA
0404-001172	D302	DIODE-SCHOTTKY	SA
0406-001190	ZD603	DIODE-TVS	SA
0406-001190	ZD604	DIODE-TVS	SA
0406-001223	ZD601	DIODE-TVS	SA
0406-001223	ZD602	DIODE-TVS	SA
0407-001002	D502	DIODE-ARRAY	SA
0504-001113	Q302	TR-DIGITAL	SA
0504-001113	Q502	TR-DIGITAL	SA
1001-001336	U602	IC-ANALOG SWITCH	SA
1001-001410	U604	IC-ANALOG SWITCH	SA
1006-001322	U701	IC-LINE TRANSCEIVER	SA
1108-000061	UME201	IC-MCP	SA
1201-002195	U603	IC-AUDIO AMP	SA
1201-002233	U601	IC-AUDIO AMP	SA
1201-002531	PAM102	IC-POWER AMP	SA
1201-002570	PAM101	IC-POWER AMP	SA
1203-003340	U506	IC-POSI.FIXED REG.	SA
1203-003787	U704	IC-POSI.FIXED REG.	SA
1203-003829	U703	IC-POSI.FIXED REG.	SA
1203-004101	PMIC500	IC-POWER SUPERVISOR	SA
1203-004373	U404	IC-POSI.FIXED REG.	SA
1203-004518	U505	IC-BATTERY	SA
1203-004682	U702	IC-MULTI REG.	SA
1205-003198	U201	IC-TRANSCEIVER	SA
1205-003215	U301	IC-MODEM	SA
1404-001224	U303	THERMISTOR-NTC	SA
1405-001082	VR401	VARISTOR	SA
1405-001082	VR402	VARISTOR	SA
1405-001110	V501	VARISTOR	SA
1405-001133	V502	VARISTOR	SA
1405-001133	VR701	VARISTOR	SA
1405-001133	VR702	VARISTOR	SA
1405-001133	VR703	VARISTOR	SA

SEC CODE	Design LOC	Discription	STATUS
1405-001133	VR704	VARISTOR	SA
1405-001133	VR705	VARISTOR	SA
1405-001133	VR707	VARISTOR	SA
1405-001133	VR708	VARISTOR	SA
1405-001133	VR709	VARISTOR	SA
1405-001133	VR710	VARISTOR	SA
1405-001133	VR713	VARISTOR	SA
1405-001177	VR403	VARISTOR	SA
1405-001177	VR711	VARISTOR	SA
1405-001177	VR712	VARISTOR	SA
2007-000141	R617	R-CHIP	SA
2007-000148	R629	R-CHIP	SA
2007-000148	R630	R-CHIP	SA
2007-000151	R538	R-CHIP	SA
2007-000154	R623	R-CHIP	SA
2007-000171	R115	R-CHIP	SA
2007-000171	R122	R-CHIP	SA
2007-000171	R127	R-CHIP	SA
2007-000171	R207	R-CHIP	SA
2007-000171	R215	R-CHIP	SA
2007-000171	R334	R-CHIP	SA
2007-000171	R335	R-CHIP	SA
2007-000171	R420	R-CHIP	SA
2007-000171	R509	R-CHIP	SA
2007-000171	R618	R-CHIP	SA
2007-000171	R638	R-CHIP	SA
2007-000171	R639	R-CHIP	SA
2007-000171	R703	R-CHIP	SA
2007-000173	R620	R-CHIP	SA
2007-000173	R622	R-CHIP	SA
2007-001119	R608	R-CHIP	SA
2007-001285	R208	R-CHIP	SA
2007-001285	R218	R-CHIP	SA
2007-001298	R100	R-CHIP	SA
2007-001298	R104	R-CHIP	SA
2007-001298	R112	R-CHIP	SA

SEC CODE	Design LOC	Discription	STATUS
2007-001305	R101	R-CHIP	SA
2007-001305	R102	R-CHIP	SA
2007-001305	R105	R-CHIP	SA
2007-001305	R106	R-CHIP	SA
2007-007009	R108	R-CHIP	SA
2007-007014	R523	R-CHIP	SA
2007-007014	R526	R-CHIP	SA
2007-007135	R327	R-CHIP	SA
2007-007137	R568	R-CHIP	SA
2007-007139	R114	R-CHIP	SA
2007-007142	R103	R-CHIP	SA
2007-007306	R110	R-CHIP	SA
2007-007309	R625	R-CHIP	SA
2007-007309	R626	R-CHIP	SA
2007-007317	R107	R-CHIP	SA
2007-007468	R517	R-CHIP	SA
2007-007528	R610	R-CHIP	SA
2007-007698	R515	R-CHIP	SA
2007-007741	R206	R-CHIP	SA
2007-007741	R303	R-CHIP	SA
2007-007741	R510	R-CHIP	SA
2007-007766	R311	R-CHIP	SA
2007-008045	R109	R-CHIP	SA
2007-008045	R113	R-CHIP	SA
2007-008045	R217	R-CHIP	SA
2007-008045	R604	R-CHIP	SA
2007-008053	R536	R-CHIP	SA
2007-008055	R317	R-CHIP	SA
2007-008055	R319	R-CHIP	SA
2007-008055	R331	R-CHIP	SA
2007-008055	R332	R-CHIP	SA
2007-008055	R534	R-CHIP	SA
2007-008055	R539	R-CHIP	SA
2007-008055	R565	R-CHIP	SA
2007-008055	R634	R-CHIP	SA
2007-008055	R635	R-CHIP	SA

SEC CODE	Design LOC	Discription	STATUS
2007-008055	R713	R-CHIP	SA
2007-008419	R533	R-CHIP	SA
2007-008419	R611	R-CHIP	SA
2007-008419	R612	R-CHIP	SA
2007-008419	R614	R-CHIP	SA
2007-008419	R615	R-CHIP	SA
2007-008478	R602	R-CHIP	SA
2007-008478	R603	R-CHIP	SA
2007-008483	R511	R-CHIP	SA
2007-008483	R701	R-CHIP	SA
2007-008483	R705	R-CHIP	SA
2007-008483	R706	R-CHIP	SA
2007-008483	R707	R-CHIP	SA
2007-008483	R709	R-CHIP	SA
2007-008483	R712	R-CHIP	SA
2007-008486	R527	R-CHIP	SA
2007-008516	R305	R-CHIP	SA
2007-008516	R306	R-CHIP	SA
2007-008516	R307	R-CHIP	SA
2007-008516	R531	R-CHIP	SA
2007-008516	R631	R-CHIP	SA
2007-008516	R633	R-CHIP	SA
2007-008531	R214	R-CHIP	SA
2007-008542	R111	R-CHIP	SA
2007-008542	R125	R-CHIP	SA
2007-008542	R210	R-CHIP	SA
2007-008542	R320	R-CHIP	SA
2007-008542	R505	R-CHIP	SA
2007-008542	R506	R-CHIP	SA
2007-008542	R508	R-CHIP	SA
2007-008542	R512	R-CHIP	SA
2007-008542	R513	R-CHIP	SA
2007-008542	R514	R-CHIP	SA
2007-008542	R520	R-CHIP	SA
2007-008542	R521	R-CHIP	SA
2007-008542	R524	R-CHIP	SA

SEC CODE	Design LOC	Discription	STATUS
2007-008542	R525	R-CHIP	SA
2007-008542	R562	R-CHIP	SA
2007-008542	R563	R-CHIP	SA
2007-008542	R619	R-CHIP	SA
2007-008542	R722	R-CHIP	SA
2007-008542	R723	R-CHIP	SA
2007-008542	R725	R-CHIP	SA
2007-008542	R726	R-CHIP	SA
2007-008544	R216	R-CHIP	SA
2007-008544	R601	R-CHIP	SA
2007-008548	R613	R-CHIP	SA
2007-008647	R211	R-CHIP	SA
2007-008647	R537	R-CHIP	SA
2007-008672	R636	R-CHIP	SA
2007-008672	R637	R-CHIP	SA
2007-008806	R310	R-CHIP	SA
2007-008806	R516	R-CHIP	SA
2007-009084	R301	R-CHIP	SA
2007-009111	R616	R-CHIP	SA
2007-009112	R329	R-CHIP	SNA
2007-009112	R330	R-CHIP	SNA
2007-009115	R304	R-CHIP	SA
2007-009155	R532	R-CHIP	SNA
2007-009167	R328	R-CHIP	SA
2007-009169	R627	R-CHIP	SA
2007-009170	R315	R-CHIP	SA
2007-009170	R606	R-CHIP	SA
2007-009171	R322	R-CHIP	SA
2007-009171	R323	R-CHIP	SA
2007-009171	R324	R-CHIP	SA
2007-009171	R325	R-CHIP	SA
2007-009212	R321	R-CHIP	SA
2007-009212	R704	R-CHIP	SA
2007-009398	R316	R-CHIP	SA
2007-009398	R535	R-CHIP	SA
2007-009409	R419	R-CHIP	SA

SEC CODE	Design LOC	Discription	STATUS
2203-000233	C132	C-CER,CHIP	SA
2203-000233	C133	C-CER,CHIP	SA
2203-000233	C137	C-CER,CHIP	SA
2203-000233	C138	C-CER,CHIP	SA
2203-000233	C139	C-CER,CHIP	SA
2203-000233	C509	C-CER,CHIP	SA
2203-000254	C122	C-CER,CHIP	SA
2203-000330	C117	C-CER,CHIP	SA
2203-000386	C254	C-CER,CHIP	SA
2203-000386	C427	C-CER,CHIP	SA
2203-000425	C513	C-CER,CHIP	SA
2203-000425	C514	C-CER,CHIP	SA
2203-000438	C121	C-CER,CHIP	SA
2203-000438	C141	C-CER,CHIP	SA
2203-000438	C245	C-CER,CHIP	SA
2203-000438	C636	C-CER,CHIP	SA
2203-000438	C641	C-CER,CHIP	SA
2203-000489	C329	C-CER,CHIP	SA
2203-000627	C130	C-CER,CHIP	SNA
2203-000627	C131	C-CER,CHIP	SNA
2203-000714	C233	C-CER,CHIP	SA
2203-000812	C100	C-CER,CHIP	SA
2203-000812	C110	C-CER,CHIP	SA
2203-000812	C111	C-CER,CHIP	SA
2203-000812	C115	C-CER,CHIP	SA
2203-000812	C124	C-CER,CHIP	SA
2203-000812	C409	C-CER,CHIP	SA
2203-000812	C410	C-CER,CHIP	SA
2203-000812	C550	C-CER,CHIP	SA
2203-000812	C551	C-CER,CHIP	SA
2203-000812	C561	C-CER,CHIP	SA
2203-000812	C603	C-CER,CHIP	SA
2203-000812	C619	C-CER,CHIP	SA
2203-000854	C113	C-CER,CHIP	SA
2203-000854	C501	C-CER,CHIP	SA
2203-000870	C101	C-CER,CHIP	SA

SEC CODE	Design LOC	Discription	STATUS
2203-000995	C107	C-CER,CHIP	SA
2203-000995	C547	C-CER,CHIP	SA
2203-000995	C621	C-CER,CHIP	SA
2203-000995	C622	C-CER,CHIP	SA
2203-001405	C618	C-CER,CHIP	SA
2203-001405	C620	C-CER,CHIP	SA
2203-001437	C255	C-CER,CHIP	SA
2203-002668	C112	C-CER,CHIP	SA
2203-002668	C140	C-CER,CHIP	SA
2203-002677	C109	C-CER,CHIP	SA
2203-005050	C104	C-CER,CHIP	SA
2203-005057	C142	C-CER,CHIP	SA
2203-005138	C640	C-CER,CHIP	SA
2203-005138	C644	C-CER,CHIP	SA
2203-005234	C146	C-CER,CHIP	SA
2203-005480	C639	C-CER,CHIP	SA
2203-005480	C645	C-CER,CHIP	SA
2203-005482	C531	C-CER,CHIP	SA
2203-005482	C532	C-CER,CHIP	SA
2203-005482	C533	C-CER,CHIP	SA
2203-005482	C554	C-CER,CHIP	SA
2203-005482	C615	C-CER,CHIP	SA
2203-005482	C634	C-CER,CHIP	SA
2203-005482	C720	C-CER,CHIP	SA
2203-005482	C725	C-CER,CHIP	SA
2203-005682	C335	C-CER,CHIP	SA
2203-005682	C710	C-CER,CHIP	SA
2203-005682	C711	C-CER,CHIP	SA
2203-005682	C712	C-CER,CHIP	SA
2203-005682	C713	C-CER,CHIP	SA
2203-005682	C714	C-CER,CHIP	SA
2203-005682	C715	C-CER,CHIP	SA
2203-005719	C327	C-CER,CHIP	SA
2203-005725	C217	C-CER,CHIP	SA
2203-005725	C218	C-CER,CHIP	SA
2203-005725	C219	C-CER,CHIP	SA

SEC CODE	Design LOC	Discription	STATUS
2203-005725	C232	C-CER,CHIP	SA
2203-005725	C239	C-CER,CHIP	SA
2203-005725	C249	C-CER,CHIP	SA
2203-005725	C250	C-CER,CHIP	SA
2203-005725	C252	C-CER,CHIP	SA
2203-005726	C225	C-CER,CHIP	SA
2203-005727	C209	C-CER,CHIP	SA
2203-005736	C231	C-CER,CHIP	SA
2203-005736	C238	C-CER,CHIP	SA
2203-005736	C336	C-CER,CHIP	SA
2203-005736	C562	C-CER,CHIP	SA
2203-005736	C629	C-CER,CHIP	SA
2203-005740	C215	C-CER,CHIP	SA
2203-005742	C211	C-CER,CHIP	SA
2203-005742	C214	C-CER,CHIP	SA
2203-005806	C222	C-CER,CHIP	SNA
2203-005806	C303	C-CER,CHIP	SNA
2203-005806	C304	C-CER,CHIP	SNA
2203-005806	C308	C-CER,CHIP	SNA
2203-005806	C309	C-CER,CHIP	SNA
2203-005806	C312	C-CER,CHIP	SNA
2203-005806	C313	C-CER,CHIP	SNA
2203-005806	C316	C-CER,CHIP	SNA
2203-005806	C321	C-CER,CHIP	SNA
2203-005806	C322	C-CER,CHIP	SNA
2203-005806	C323	C-CER,CHIP	SNA
2203-005806	C324	C-CER,CHIP	SNA
2203-005806	C325	C-CER,CHIP	SNA
2203-005806	C528	C-CER,CHIP	SNA
2203-005806	C529	C-CER,CHIP	SNA
2203-005806	C701	C-CER,CHIP	SNA
2203-005808	C248	C-CER,CHIP	SA
2203-006047	C328	C-CER,CHIP	SA
2203-006048	C106	C-CER,CHIP	SA
2203-006120	C123	C-CER,CHIP	SA
2203-006120	C205	C-CER,CHIP	SA

SEC CODE	Design LOC	Discription	STATUS
2203-006120	C206	C-CER,CHIP	SA
2203-006120	C207	C-CER,CHIP	SA
2203-006120	C208	C-CER,CHIP	SA
2203-006137	C626	C-CER,CHIP	SA
2203-006194	C129	C-CER,CHIP	SA
2203-006194	C212	C-CER,CHIP	SA
2203-006194	C337	C-CER,CHIP	SA
2203-006194	C546	C-CER,CHIP	SA
2203-006324	C120	C-CER,CHIP	SA
2203-006324	C307	C-CER,CHIP	SA
2203-006324	C503	C-CER,CHIP	SA
2203-006324	C553	C-CER,CHIP	SA
2203-006348	C507	C-CER,CHIP	SA
2203-006348	C549	C-CER,CHIP	SA
2203-006399	C563	C-CER,CHIP	SA
2203-006423	C201	C-CER,CHIP	SA
2203-006423	C202	C-CER,CHIP	SA
2203-006423	C203	C-CER,CHIP	SA
2203-006423	C204	C-CER,CHIP	SA
2203-006423	C213	C-CER,CHIP	SA
2203-006423	C221	C-CER,CHIP	SA
2203-006423	C226	C-CER,CHIP	SA
2203-006423	C228	C-CER,CHIP	SA
2203-006423	C229	C-CER,CHIP	SA
2203-006423	C230	C-CER,CHIP	SA
2203-006423	C240	C-CER,CHIP	SA
2203-006423	C241	C-CER,CHIP	SA
2203-006423	C242	C-CER,CHIP	SA
2203-006423	C243	C-CER,CHIP	SA
2203-006423	C244	C-CER,CHIP	SA
2203-006423	C301	C-CER,CHIP	SA
2203-006423	C302	C-CER,CHIP	SA
2203-006423	C305	C-CER,CHIP	SA
2203-006423	C306	C-CER,CHIP	SA
2203-006423	C310	C-CER,CHIP	SA
2203-006423	C314	C-CER,CHIP	SA

SEC CODE	Design LOC	Discription	STATUS
2203-006423	C317	C-CER,CHIP	SA
2203-006423	C318	C-CER,CHIP	SA
2203-006423	C319	C-CER,CHIP	SA
2203-006423	C320	C-CER,CHIP	SA
2203-006423	C326	C-CER,CHIP	SA
2203-006423	C334	C-CER,CHIP	SA
2203-006423	C422	C-CER,CHIP	SA
2203-006423	C511	C-CER,CHIP	SA
2203-006423	C515	C-CER,CHIP	SA
2203-006423	C521	C-CER,CHIP	SA
2203-006423	C525	C-CER,CHIP	SA
2203-006423	C716	C-CER,CHIP	SA
2203-006439	C143	C-CER,CHIP	SNA
2203-006439	C223	C-CER,CHIP	SNA
2203-006439	C224	C-CER,CHIP	SNA
2203-006466	C624	C-CER,CHIP	SA
2203-006562	C236	C-CER,CHIP	SA
2203-006562	C311	C-CER,CHIP	SA
2203-006562	C315	C-CER,CHIP	SA
2203-006562	C423	C-CER,CHIP	SA
2203-006562	C542	C-CER,CHIP	SA
2203-006562	C543	C-CER,CHIP	SA
2203-006562	C548	C-CER,CHIP	SA
2203-006562	C555	C-CER,CHIP	SA
2203-006562	C556	C-CER,CHIP	SA
2203-006562	C602	C-CER,CHIP	SA
2203-006562	C630	C-CER,CHIP	SA
2203-006562	C631	C-CER,CHIP	SA
2203-006562	C635	C-CER,CHIP	SA
2203-006562	C637	C-CER,CHIP	SA
2203-006562	C638	C-CER,CHIP	SA
2203-006562	C642	C-CER,CHIP	SA
2203-006562	C643	C-CER,CHIP	SA
2203-006562	C702	C-CER,CHIP	SA
2203-006562	C719	C-CER,CHIP	SA
2203-006562	C722	C-CER,CHIP	SA

SEC CODE	Design LOC	Discription	STATUS
2203-006648	C340	C-CER,CHIP	SA
2203-006648	C341	C-CER,CHIP	SA
2203-006681	C502	C-CER,CHIP	SA
2203-006681	C623	C-CER,CHIP	SA
2203-006681	C646	C-CER,CHIP	SA
2203-006824	C235	C-CER,CHIP	SA
2203-006824	C251	C-CER,CHIP	SA
2203-006824	C508	C-CER,CHIP	SA
2203-006824	C517	C-CER,CHIP	SA
2203-006824	C518	C-CER,CHIP	SA
2203-006824	C520	C-CER,CHIP	SA
2203-006824	C522	C-CER,CHIP	SA
2203-006824	C527	C-CER,CHIP	SA
2203-006824	C530	C-CER,CHIP	SA
2203-006824	C721	C-CER,CHIP	SA
2203-006825	C534	C-CER,CHIP	SA
2203-006872	C135	C-CER,CHIP	SA
2203-006872	C136	C-CER,CHIP	SA
2203-006872	C144	C-CER,CHIP	SA
2203-006872	C519	C-CER,CHIP	SA
2203-006872	C523	C-CER,CHIP	SA
2203-006872	C524	C-CER,CHIP	SA
2203-006872	C539	C-CER,CHIP	SA
2203-006872	C541	C-CER,CHIP	SA
2203-006872	C627	C-CER,CHIP	SA
2203-006872	C628	C-CER,CHIP	SA
2203-006872	C723	C-CER,CHIP	SA
2203-006872	C724	C-CER,CHIP	SA
2203-006979	C119	C-CER,CHIP	SA
2404-001377	C614	C-TA,CHIP	SA
2404-001381	C118	C-TA,CHIP	SA
2404-001381	C633	C-TA,CHIP	SA
2404-001411	C108	C-TA,CHIP	SA
2404-001411	C625	C-TA,CHIP	SA
2404-001415	TA704	C-TA,CHIP	SA
2404-001448	C611	C-TA,CHIP	SA

SEC CODE	Design LOC	Discription	STATUS
2404-001448	C617	C-TA,CHIP	SA
2404-001492	C601	C-TA,CHIP	SA
2703-001751	L111	INDUCTOR-SMD	SA
2703-002155	L100	INDUCTOR-SMD	SA
2703-002200	L101	INDUCTOR-SMD	SA
2703-002200	L104	INDUCTOR-SMD	SA
2703-002201	L106	INDUCTOR-SMD	SA
2703-002201	L109	INDUCTOR-SMD	SA
2703-002267	L105	INDUCTOR-SMD	SA
2703-002267	L107	INDUCTOR-SMD	SA
2703-002267	L108	INDUCTOR-SMD	SA
2703-002267	L110	INDUCTOR-SMD	SA
2703-002313	L601	INDUCTOR-SMD	SA
2703-002313	L602	INDUCTOR-SMD	SA
2703-002365	L112	INDUCTOR-SMD	SA
2703-002782	L502	INDUCTOR-SMD	SA
2703-002782	L503	INDUCTOR-SMD	SA
2703-002798	L201	INDUCTOR-SMD	SNA
2703-002798	L202	INDUCTOR-SMD	SNA
2703-002798	L204	INDUCTOR-SMD	SNA
2703-002917	L205	INDUCTOR-SMD	SA
2703-002919	L203	INDUCTOR-SMD	SA
2703-002961	L605	INDUCTOR-SMD	SA
2703-002961	L606	INDUCTOR-SMD	SA
2801-004339	OSC501	CRYSTAL-SMD	SA
2809-001280	TCX101	OSCILLATOR-VCTCXO	SA
2901-001409	F401	FILTER-EMI SMD	SA
2901-001409	F402	FILTER-EMI SMD	SA
2901-001409	F403	FILTER-EMI SMD	SA
2901-001409	F404	FILTER-EMI SMD	SA
2901-001409	F405	FILTER-EMI SMD	SA
2904-001600	F106	FILTER-SAW	SA
2904-001604	F105	FILTER-SAW	SNA
2904-001628	F104	FILTER-SAW	SA
2904-001658	F103	FILTER-SAW	SA
2904-001769	F202	FILTER-SAW	SA

SEC CODE	Design LOC	Discription	STATUS
2910-000028	DUP101	DUPLEXER-SAW	SA
2911-000085	F107	DUPLEXER-FEM	SA
3301-001208	L603	BEAD-SMD	SA
3301-001208	L604	BEAD-SMD	SA
3301-001534	L504	BEAD-SMD	SA
3404-001152	V_DN	SWITCH-TACT	SA
3404-001152	V_UP	SWITCH-TACT	SA
3404-001320	CAM	SWITCH-TACT	SA
3705-001358	RFS101	CONNECTOR-COAXIAL	SA
3709-001447	SIM501	CONNECTOR-CARD EDGE	SA
3709-001448	HDC701	CONNECTOR-CARD EDGE	SA
3710-002465	IFC601	SOCKET-INTERFACE	SA
3711-005933	HDC401	HEADER-BOARD TO BOARD	SA
3711-005976	HDC703	HEADER-BOARD TO BOARD	SA
3711-006217	BTC500	HEADER-BATTERY	SA
4202-001225	ANT103	ANTENNA-CHIP	SA
4302-001130	BAT500	BATTERY-LI(2ND)	SA
4709-001398	BT101	BLUETOOTH MODULE	SA
4709-001399	F101	COUPLER-DIRECTION	SA

8. Reference data

8-1. Reference Abbreviate

AAC: Advanced Audio Coding.

AVC : Advanced Video Coding.

BER : Bit Error Rate

BPSK: Binary Phase Shift Keying

CA : Conditional Access

CDM : Code Division Multiplexing

C/I : Carrier to Interference

DMB : Digital Multimedia Broadcasting

EN : European Standard

ES : Elementary Stream

ETSI: European Telecommunications Standards Institute

MPEG: Moving Picture Experts Group

PN : Pseudo-random Noise

PS : Pilot Symbol

QPSK: Quadrature Phase Shift Keying

RS : Reed-Solomon

SI : Service Information

TDM : Time Division Multiplexing

TS : Transport Stream

9. Safety Precautions

9-1. Repair Precaution

- Repair in Shield Box, during detailed tuning.
Take specially care of tuning or test,
because specipicty of cellular phone is sensitive for surrounding interference(RF noise).
- Be careful to use a kind of magnetic object or tool,
because performance of parts is damaged by the influence of manetic force.
- Surely use a standard screwdriver when you disassemble this product,
otherwise screw will be worn away.
- Use a thicken twisted wire when you measure level.
A thicken twisted wire has low resistance, therefore error of measurement is few.
- Repair after separate Test Pack and Set because for short danger (for example an
overcurrent and furious flames of parts etc) when you repair board in condition of
connecting Test Pack and tuning on.
- Take specially care of soldering, because Land of PCB is small and weak in heat.
- Surely tune on/off while using AC power plug, because a repair of battery charger is
dangerous when tuning ON/OFF PBA and Connector after disassembling charger.
- Don't use as you pleases after change other material than replacement registered on SEC
System.
Otherwise engineer in charge isn't charged with problem that you don't keep this rules.

9-2. ESD(Electrostatically Sensitive Devices) Precaution

Several semiconductor may be damaged easily by static electricity. Such parts are called by ESD(Electrostatically Sensitive Devices), for example IC,BGA chip etc. Read Precaution below. You can prevent from ESD damage by static electricity.

- Remove static electricity remained your body before you touch semiconductor or parts with semiconductor. There are ways that you touch an earthed place or wear static electricity prevention string on wrist.
- Use earthed soldering steel when you connect or disconnect ESD.
- Use soldering removing tool to break static electricity. , otherwise ESD will be damaged by static electricity.
- Don't unpack until you set up ESD on product. Because most of ESD are packed by box and aluminum plate to have conductive power,they are prevented from static electricity.
- You must maintain electric contact between ESD and place due to be set up until ESD is connected completely to the proper place or a circuit board.

10. Product Function

Main Function

- 3G
- Camera and camcorder
- Synchronisation with Windows Media Player
- Music player
- Java
- Image editor
- Digital data printing
- Bluetooth
- File viewer
- Web browser
- Calendar

**SAMSUNG
ELECTRONICS**



GSPN (Global Service Partner Network)

Country	Web Site
North America	service.samsungportal.com
Latin America	latin.samsungportal.com
CIS	cis.samsungportal.com
Europe	europe.samsungportal.com
China	china.samsungportal.com
Asia	asia.samsungportal.com
Mideast & Africa	mea.samsungportal.com