

SAMSUNG

**GSM TELEPHONE
SGH-D100/D100A**

SERVICE *Manual*

GSM TELEPHONE



SGH-D100

SGH-D100A

CONTENTS

1. Specification
2. Flow Chart of Troubleshooting
3. Exploded Views and Parts List
4. Electrical Parts List
5. Block Diagrams
6. PCB Diagrams

1. SGH-D100/D100A Specification

1. GSM General Specification

	GSM900 Phase 1	EGSM 900 Phase 2	DCS1800 Phase 1	PCS1900
Freq. Band[MHz] Uplink/Downlink	890~915 935~960	880~915 925~960	1710~1785 1805~1880	1850~1910 1930~1990
ARFCN range	1~124	0~124 & 975~1023	512~885	512~810
Tx/Rx spacing	45MHz	45MHz	95MHz	80MHz
Mod. Bit rate/ Bit Period	270.833kbps 3.692us	270.833kbps 3.692us	270.833kbps 3.692us	270.833kbps 3.692us
Time Slot Period/Frame Period	576.9us 4.615ms	576.9us 4.615ms	576.9us 4.615ms	576.9us 4.615ms
Modulation	0.3GMSK	0.3GMSK	0.3GMSK	0.3GMSK
MS Power	33dBm~13dBm	33dBm~5dBm	30dBm~0dBm	30dBm~0dBm
Power Class	5pcl ~ 15pcl	5pcl ~ 19pcl	0pcl ~ 15pcl	0pcl ~ 15pcl
Sensitivity	-102dBm	-102dBm	-100dBm	-100dBm
TDMA Mux	8	8	8	8
Cell Radius	35Km	35Km	2Km	-

2. GSM TX power class

TX Power control level	GSM900	TX Power control level	DCS1800	TX Power control level	PCS1900
5	33±2 dBm	0	30±3 dBm	0	30±3 dBm
6	31±2 dBm	1	28±3 dBm	1	28±3 dBm
7	29±2 dBm	2	26±3 dBm	2	26±3 dBm
8	27±2 dBm	3	24±3 dBm	3	24±3 dBm
9	25±2 dBm	4	22±3 dBm	4	22±3 dBm
10	23±2 dBm	5	20±3 dBm	5	20±3 dBm
11	21±2 dBm	6	18±3 dBm	6	18±3 dBm
12	19±2 dBm	7	16±3 dBm	7	16±3 dBm
13	17±2 dBm	8	14±3 dBm	8	14±3 dBm
14	15±2 dBm	9	12±4 dBm	9	12±4 dBm
15	13±2 dBm	10	10±4 dBm	10	10±4 dBm
16	11±3 dBm	11	8±4dBm	11	8±4dBm
17	9±3dBm	12	6±4 dBm	12	6±4 dBm
18	7±3 dBm	13	4±4 dBm	13	4±4 dBm
19	5±3 dBm	14	2±5 dBm	14	2±5 dBm
		15	0±5 dBm	15	0±5 dBm

2. SGH-D100/D100A Flow Chart of Troubleshooting

1. Baseband

1. Power ON

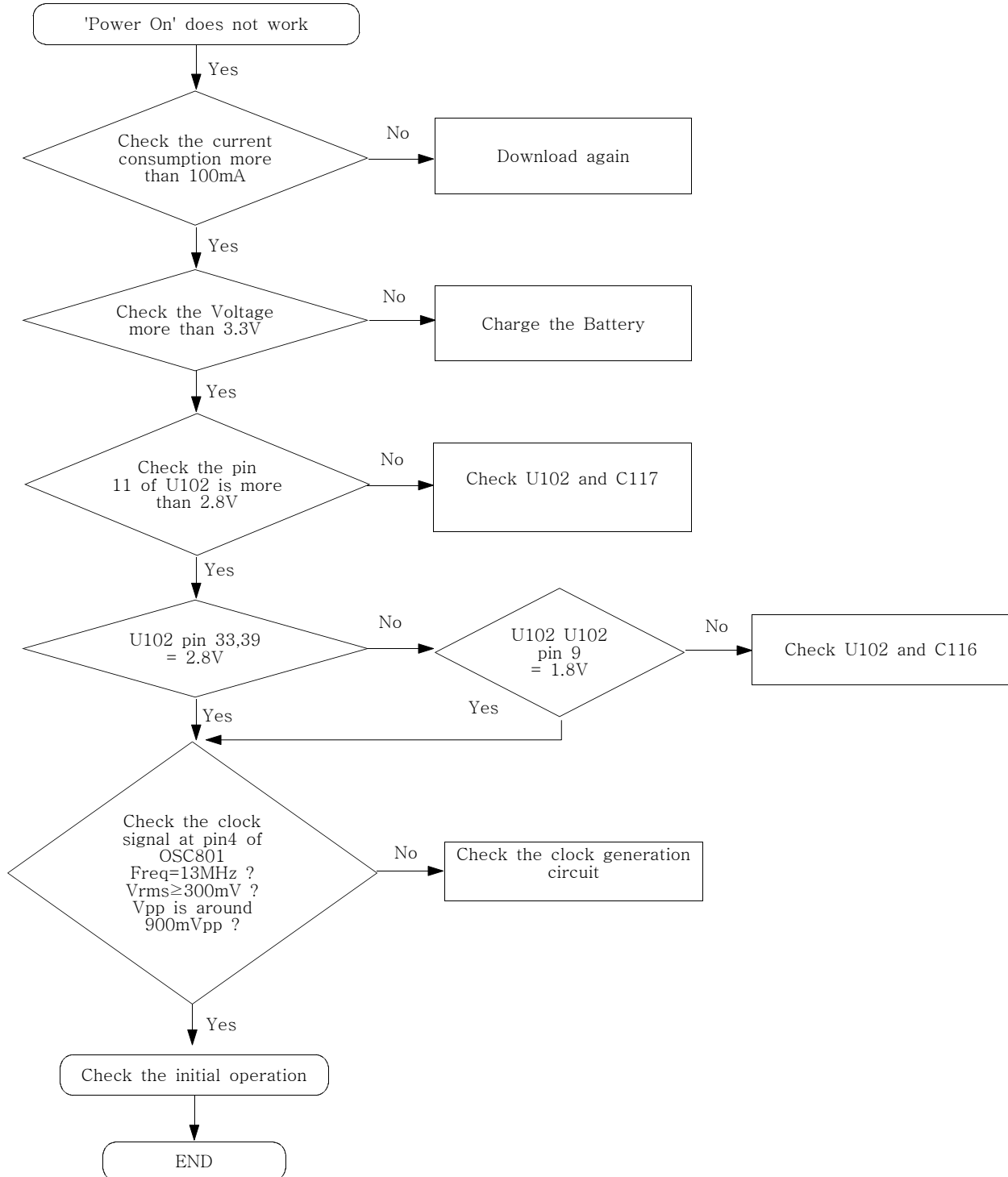

2. Initial

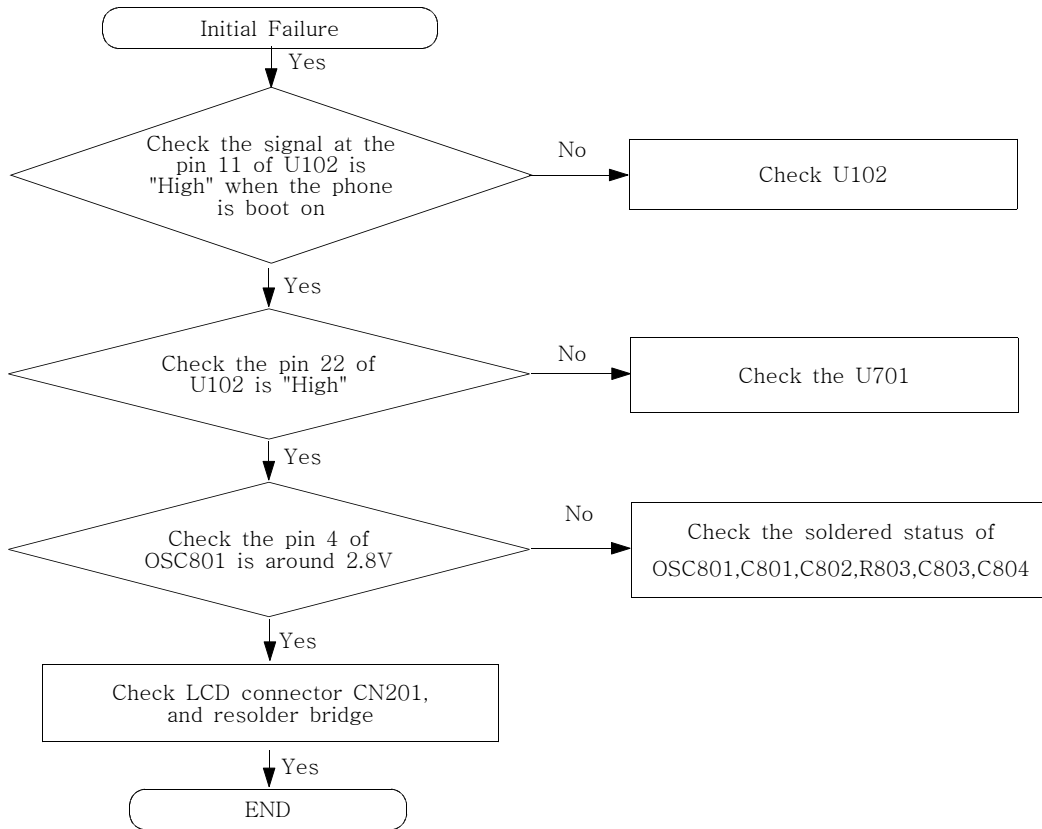

3. Sim Part

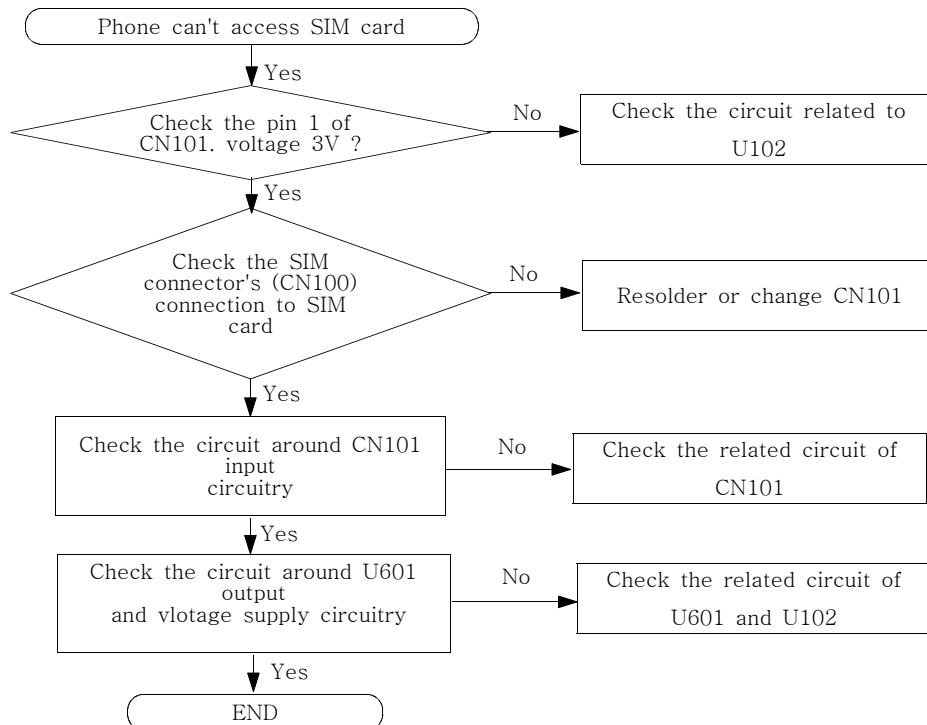

4. Charging Part

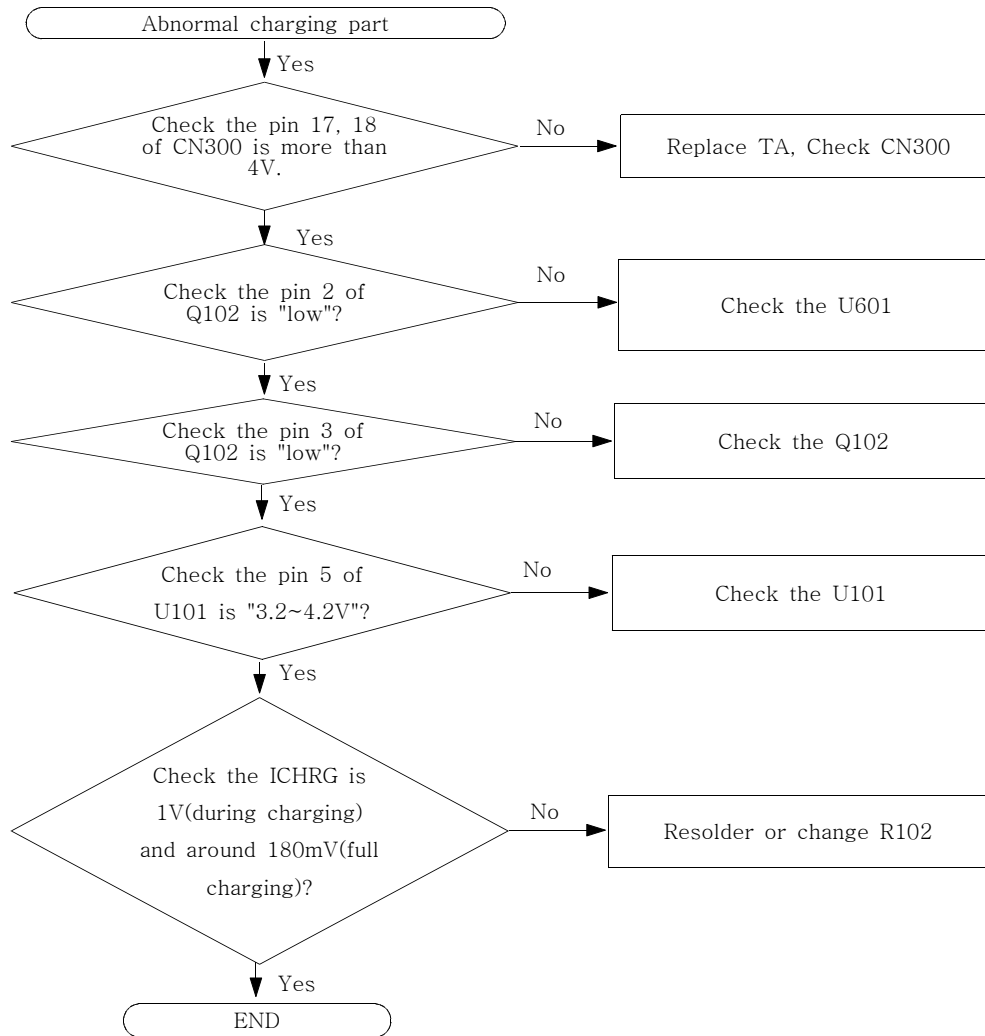

SGH-D100/D100A Flow Chart of Troubleshooting and Circuit Diagrams

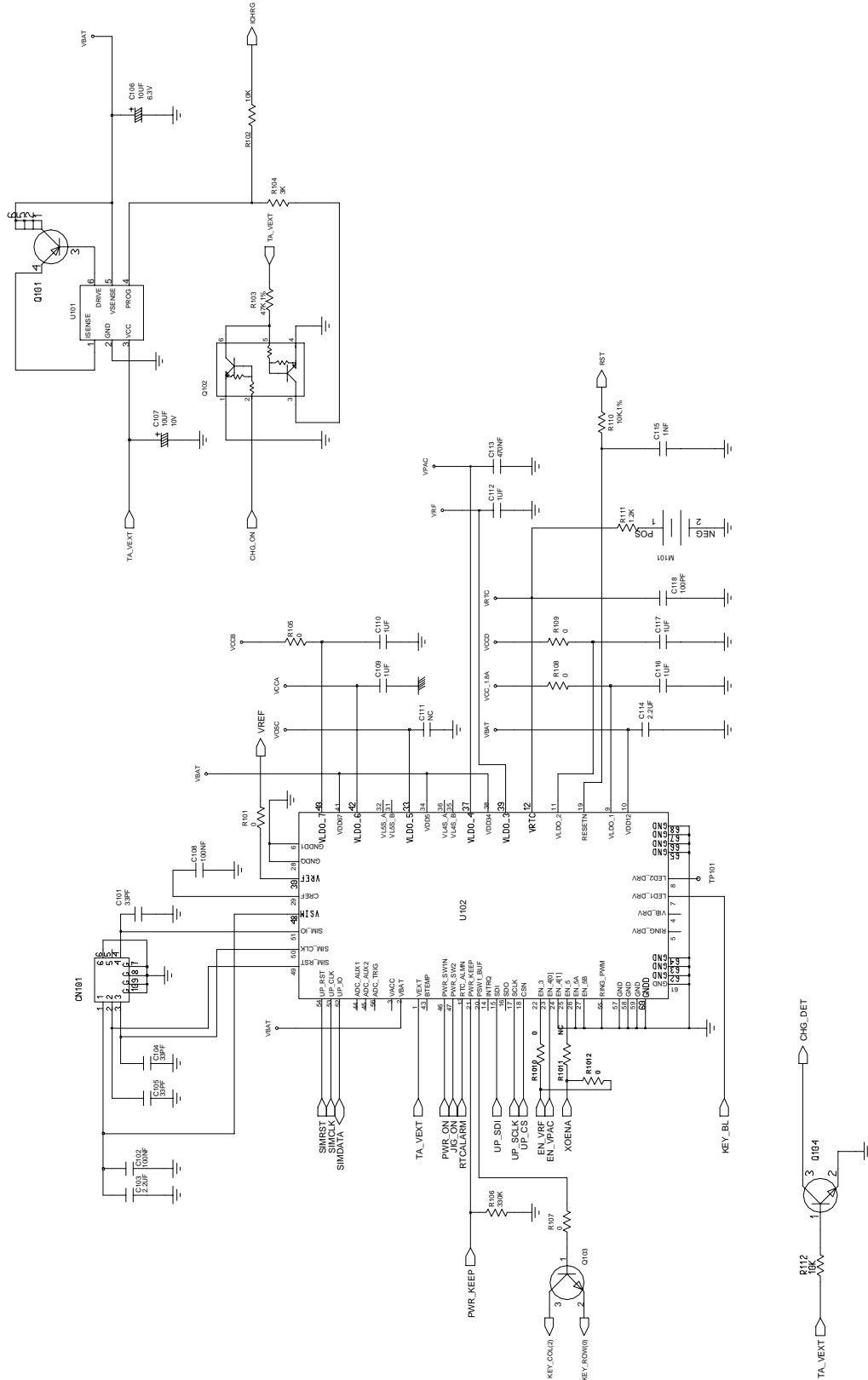

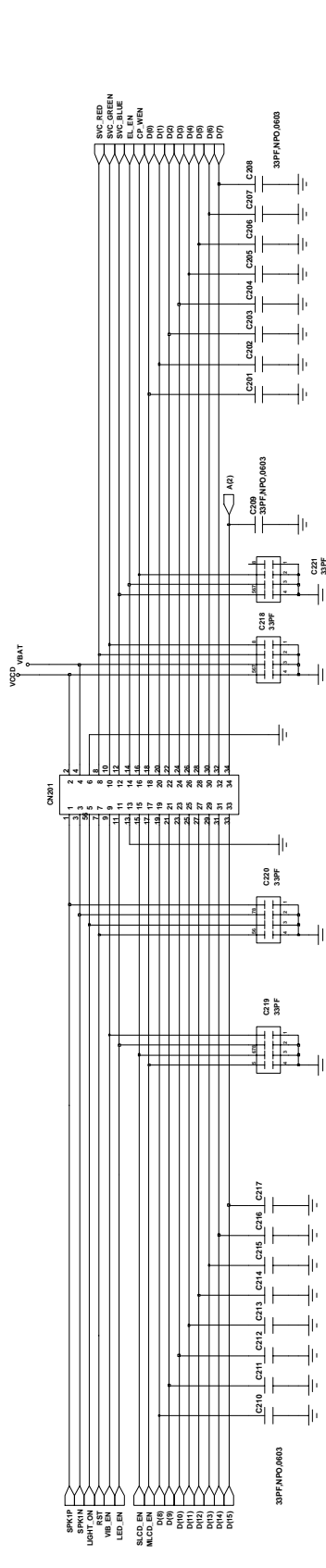

LCD CONNECTOR

JTAG CON

IRDA

KEYPAD

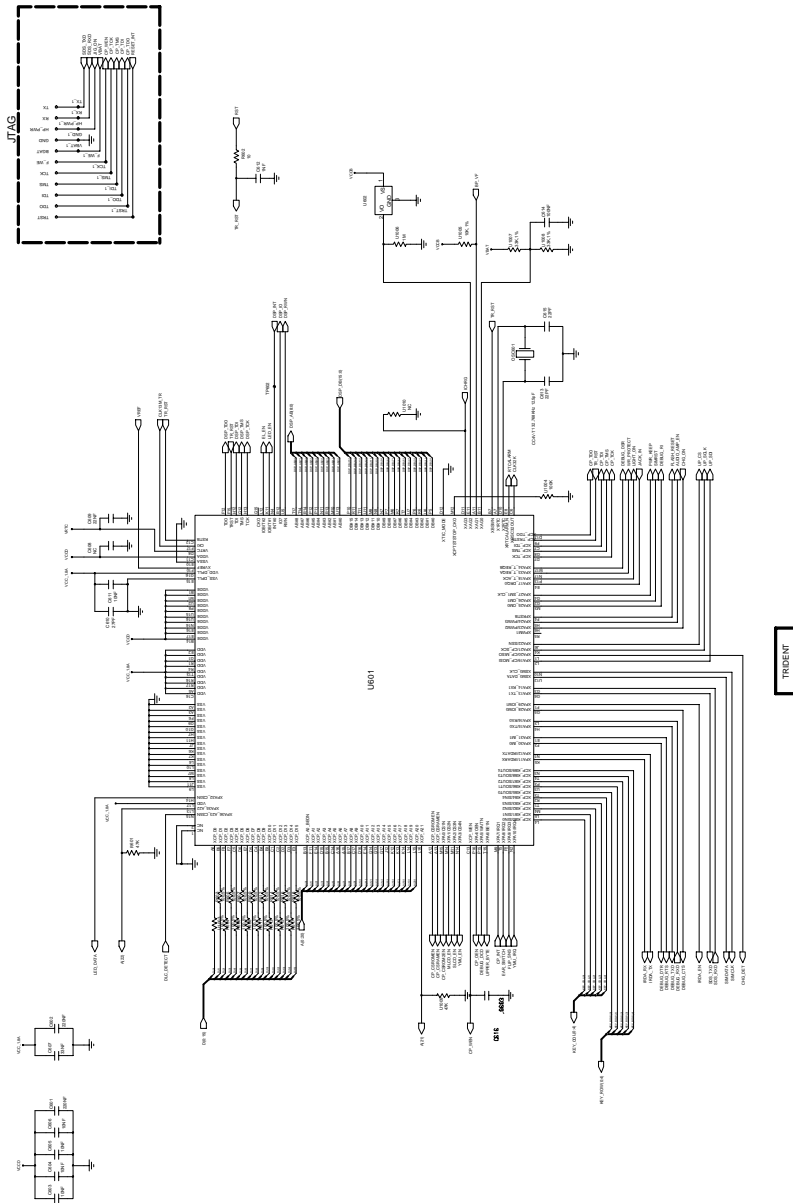

5. Microphone Part

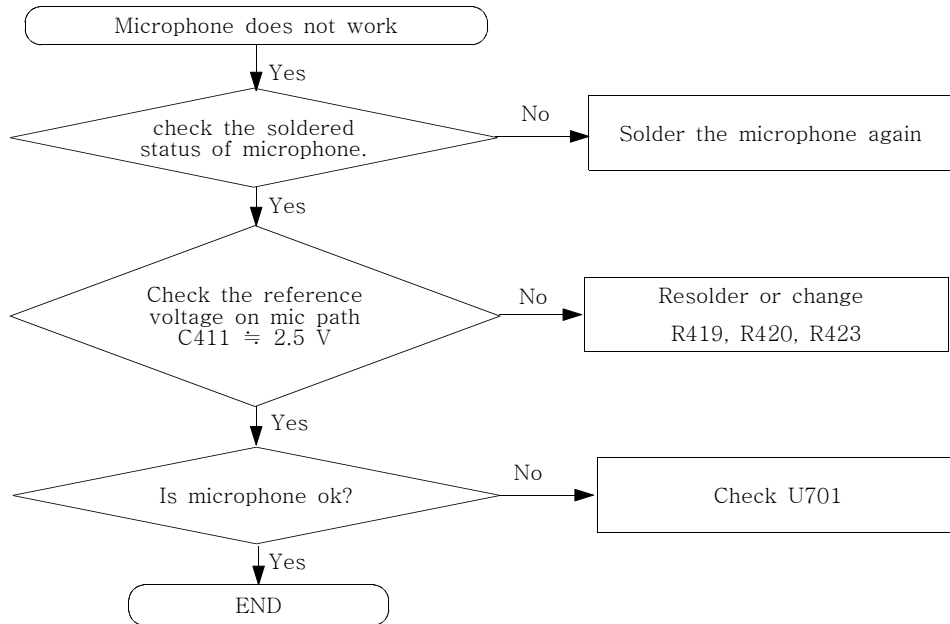

6. Speaker Part

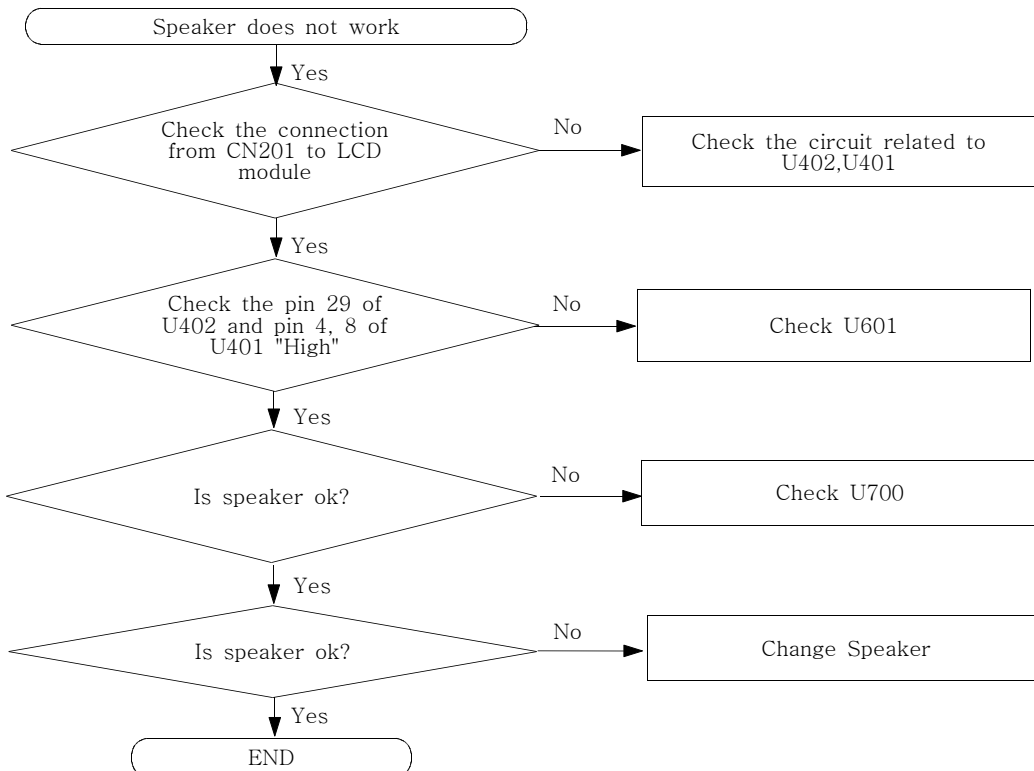

SGH-D100/D100A Flow Chart of Troubleshooting and Circuit Diagrams

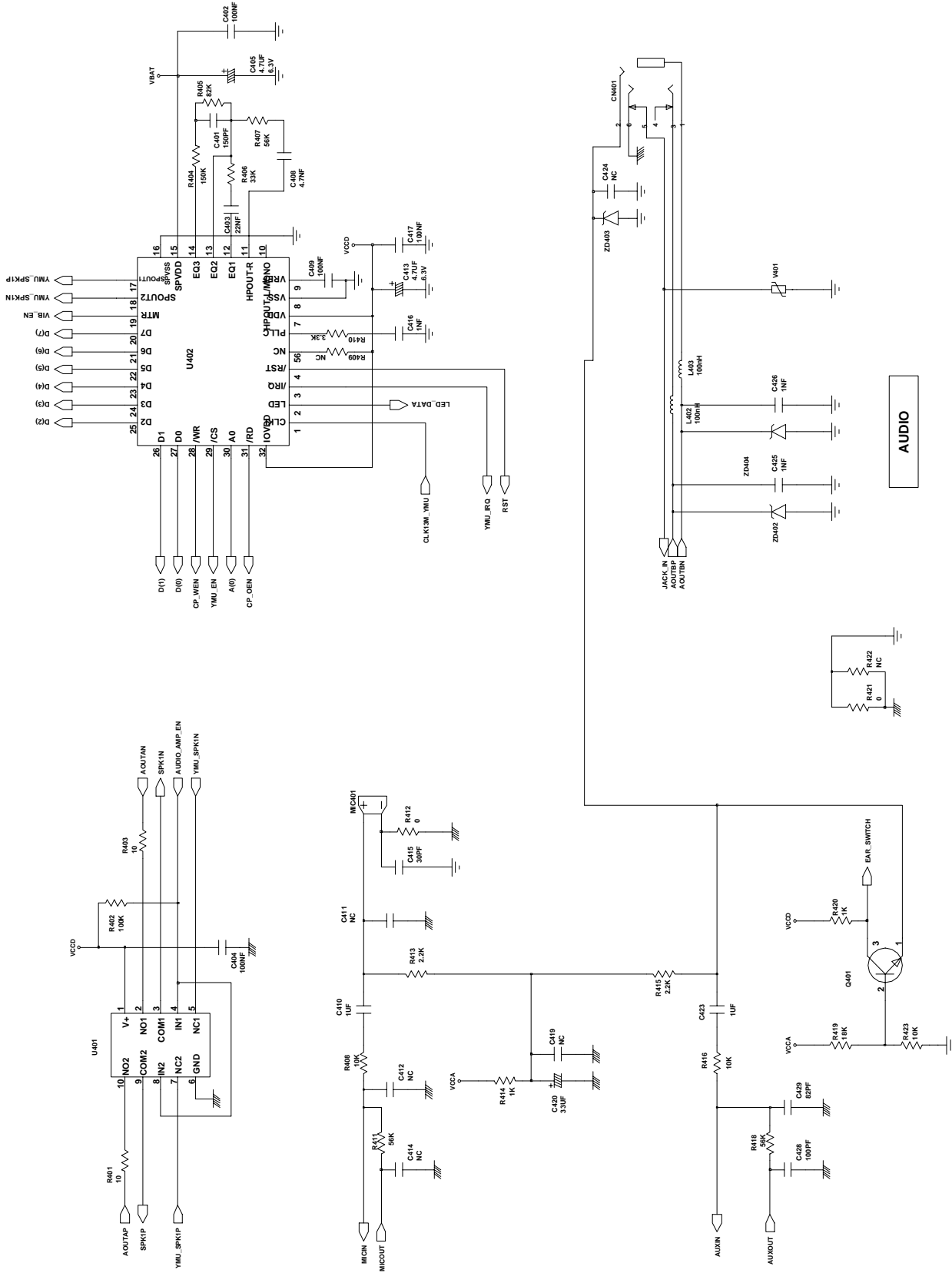

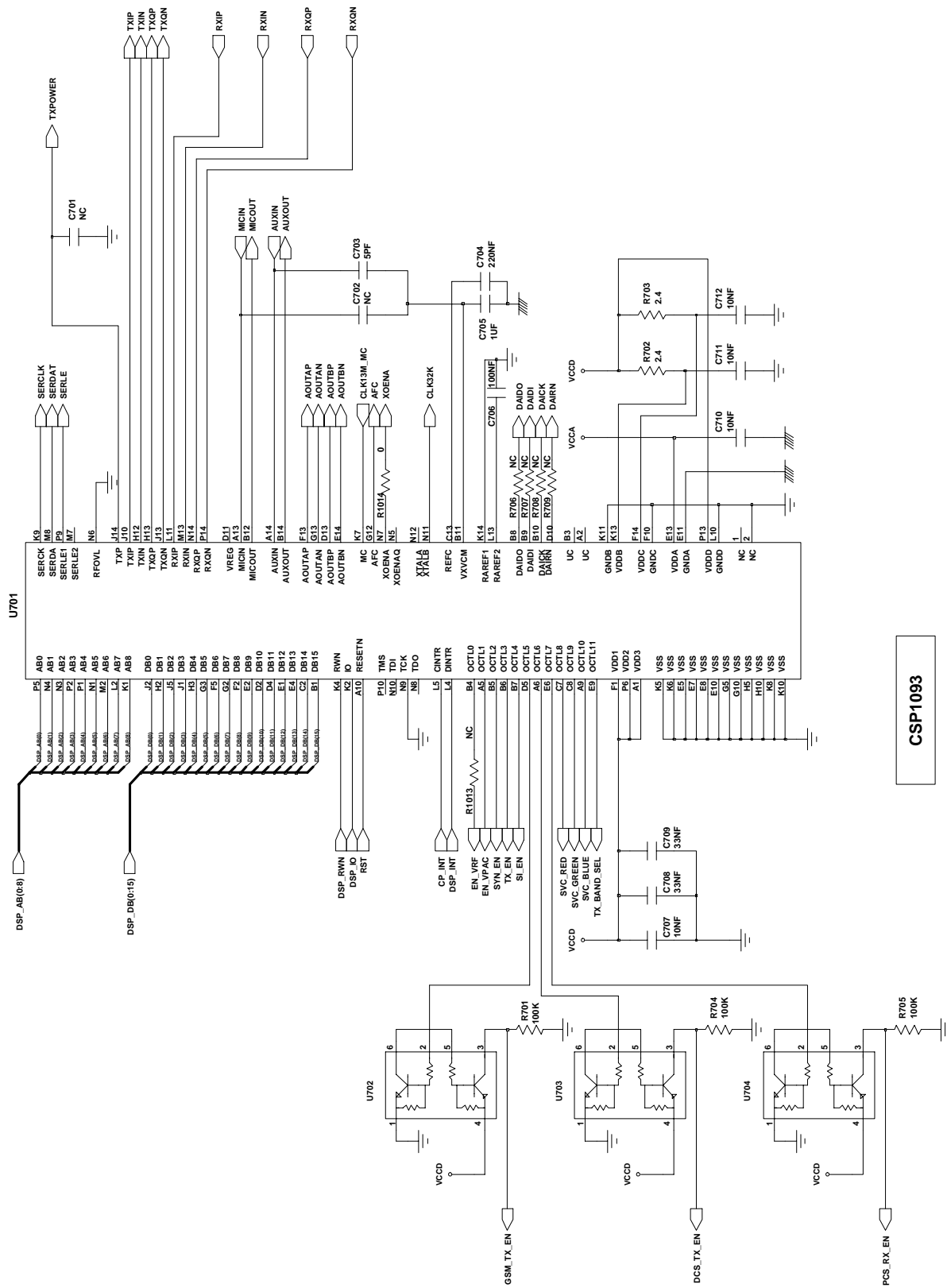

2.RF

1. EGSM RX

CONTINUOUS RX ON
RF INPUT : 62CH
AMP : -50dBm

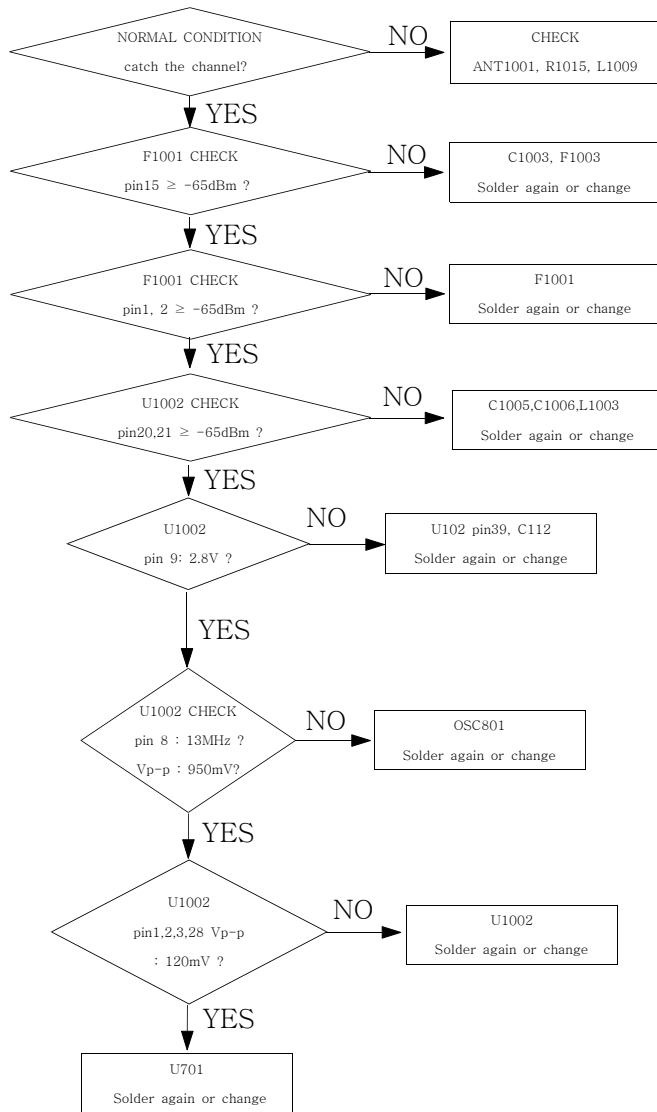

2. DCS RX

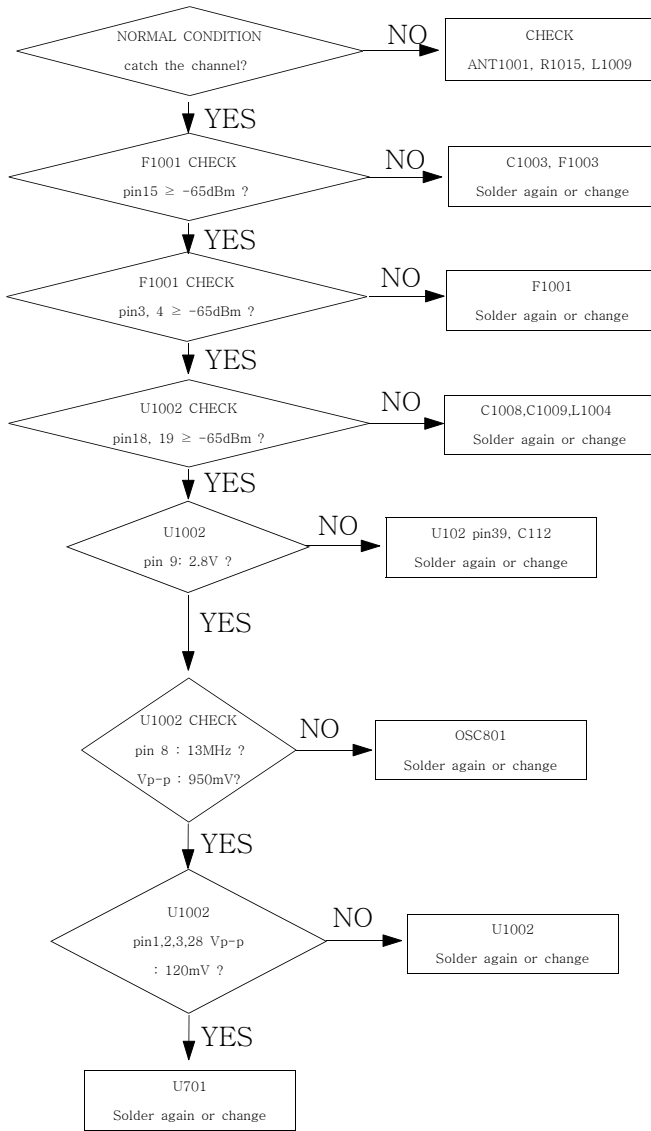

CONTINUOUS RX ON
RF INPUT : 698CH
AMP : -50dBm

3. PCS RX

CONTINUOUS RX ON
RF INPUT : 660CH
AMP : -50dBm

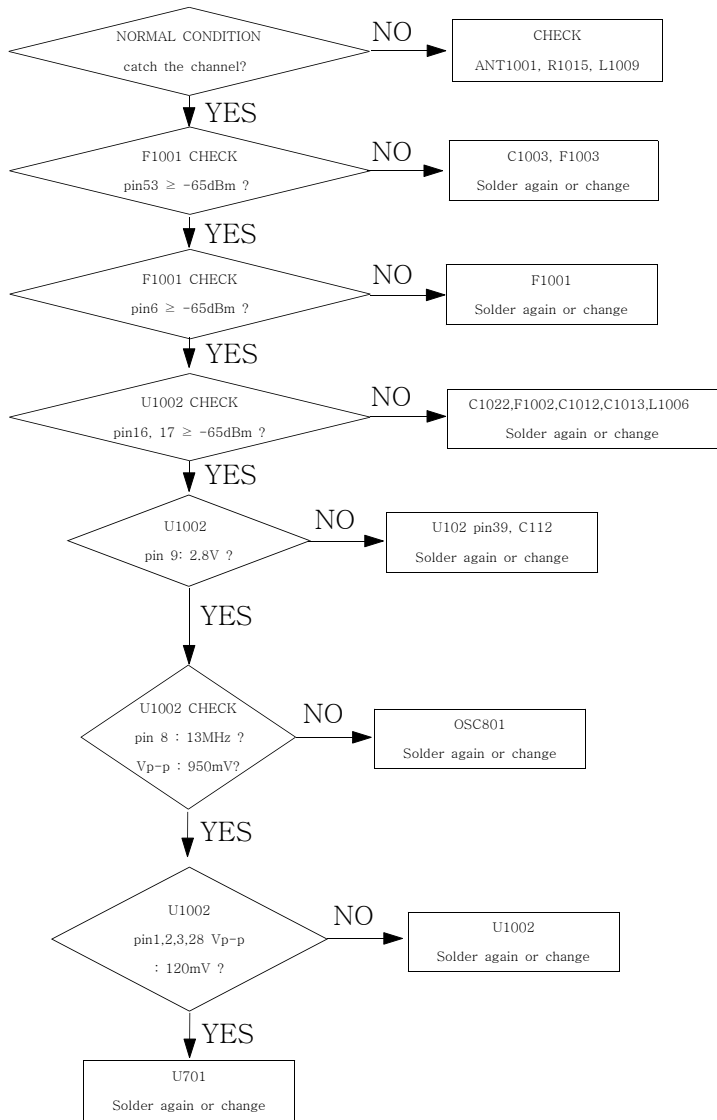

4. EGSM TX

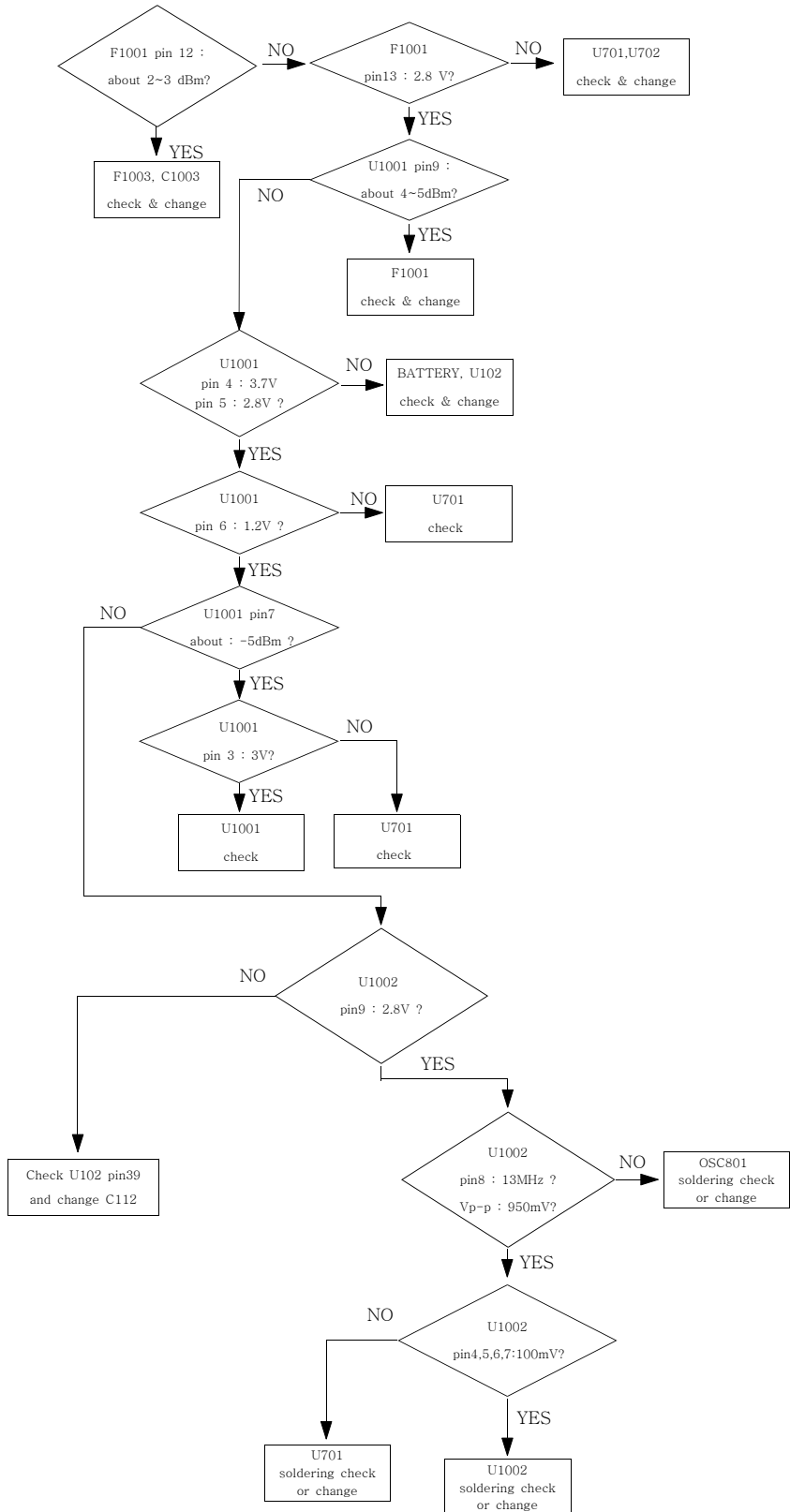

CONTINUS TX ON CONDITION
 Tx Power DAC Value: 550 Code applied
 CH : 62
 RBW : 100KHz
 VBW : 100KHz
 SPAN : 10MHz
 REF LEV. : 10dBm
 ATT. : 20dB

5. DCS/PCS TX

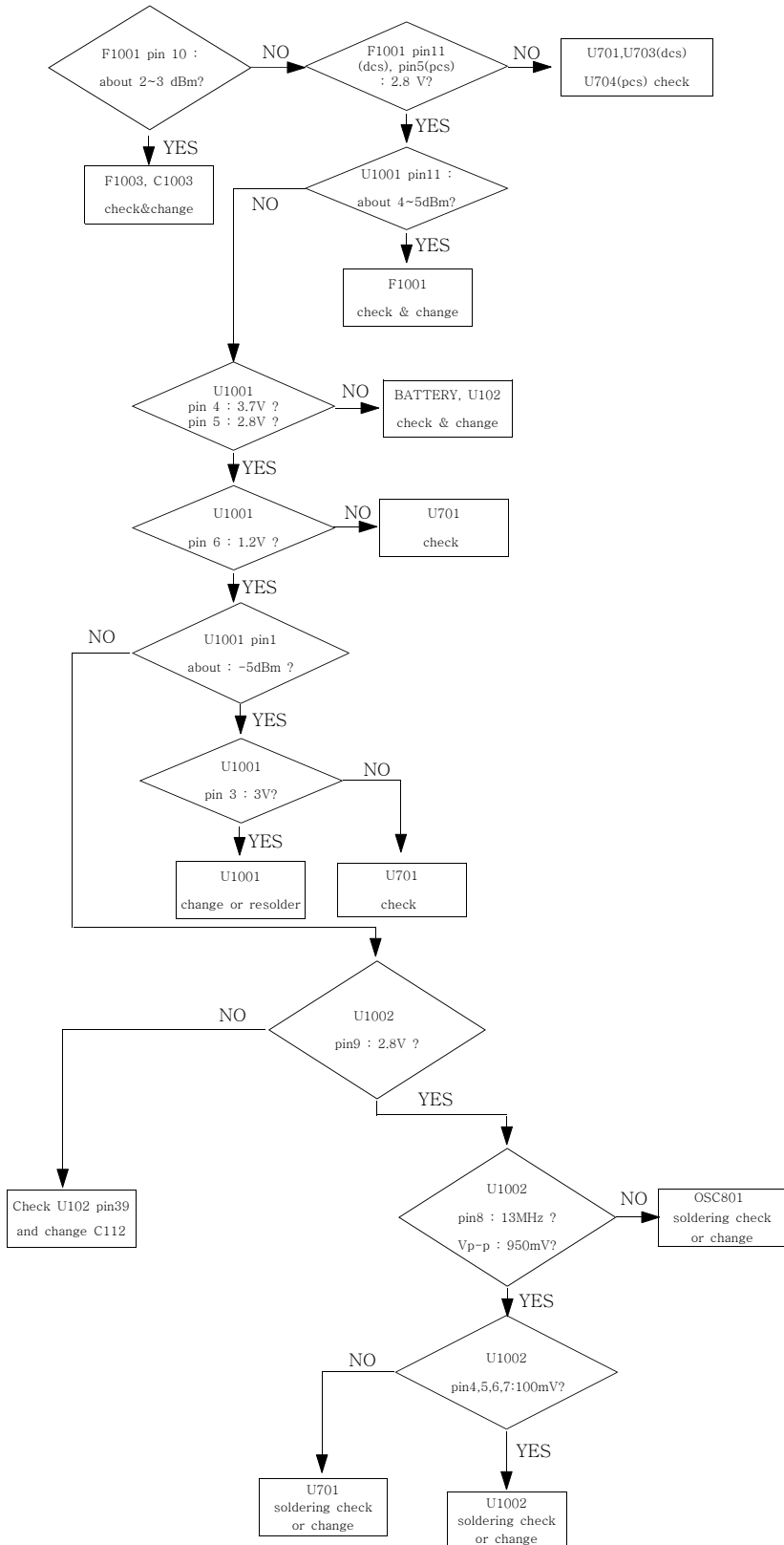

CONTINUOUS TX ON CONDITION
 CH : 698CH(DCS), 660CH(PCS)
 Tx Power DAC Value: 500 Code Applied(DCS)
 550 Code Applied(PCS)
 RBW : 100KHz
 VBW : 100KHz
 SPAN : 10MHz
 REF LEV. : 10dBm
 ATT. : 20dB

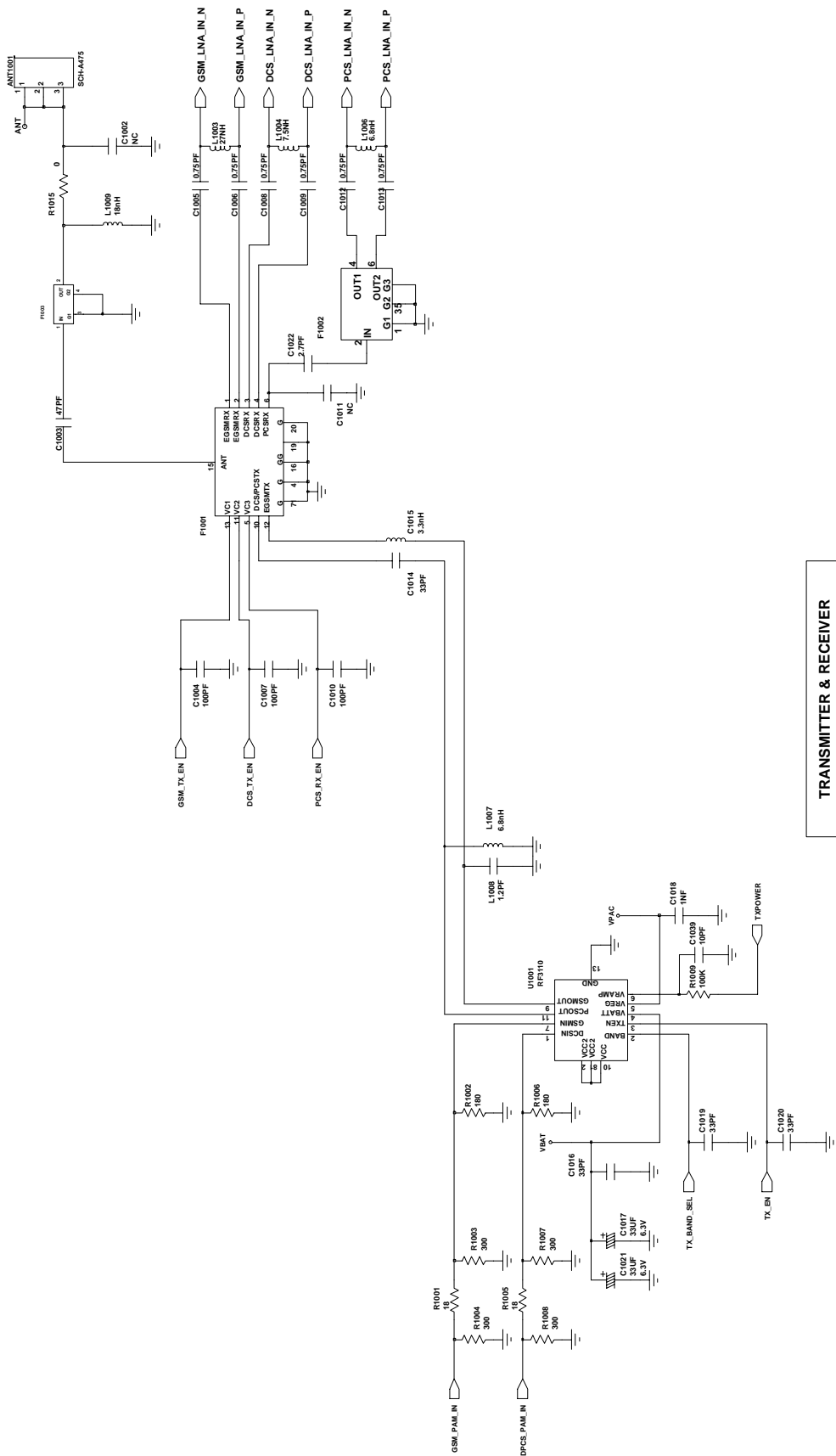

TRANSMITTER & RECEIVER

3. SGH-D100/D100A Exploded View and its Parts list

1. Cellular phone Exploded View (SGH-D100)

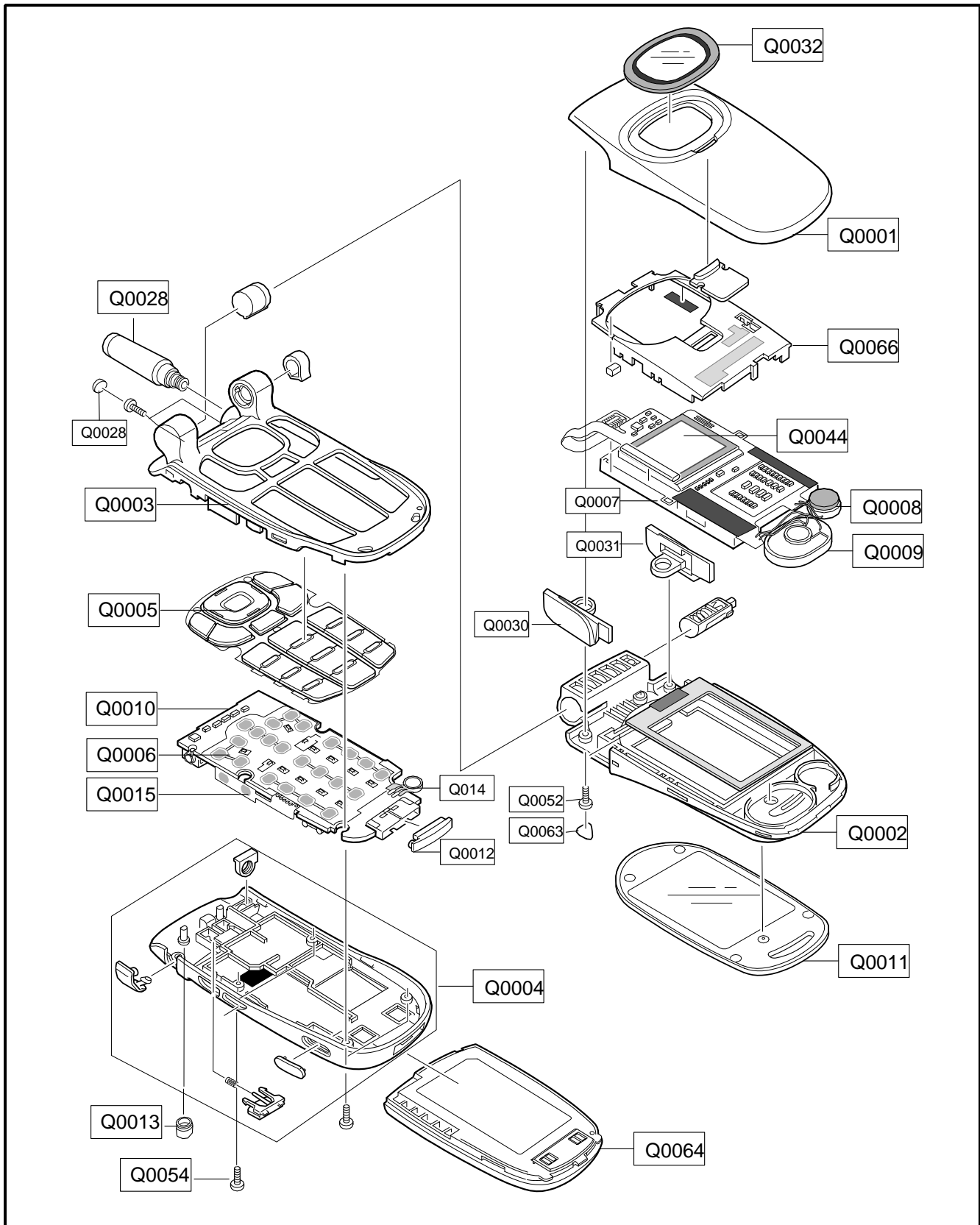

2. Cellular phone Parts list (SGH-D100)

Location NO.	Description	SEC CODE	Remark
Q0001	MEC-F/ UPPER	GH75-03165A	
Q0002	MEC-F/ LOWER	GH75-03164A	
Q0003	MEC-FRONT COVER	GH75-03163A	
Q0004	MEC-REAR COVER	GH75-03166A	
Q0005	MEC-KEYPAD	GH75-03246A	
Q0006	UNIT-METAL DOME	GH59-00897A	
Q0007	LCD	GH07-00190A	
Q0008	MOTOR DC	GH31-00036A	
Q0009	MICRO SPEAKER	3001-001429	
Q0010	PBA MAIN	GH92-01486A	
Q0011	PMO WINDOW MAIN	GH72-06272A	
Q0012	RMO NEW IF CONN COVER	GH72-02504A	
Q0013	PMO NEW RF JACK COVER	GH72-09753A	
Q0014	MICROPHONE-ASSY	GH30-00033A	
Q0015	UNIT-VOL KEY	GH59-01025A	
Q0020	ANTENNA	GH42-00305A	
Q0028	MPR FRONT SCREW CAP	GH74-06303A	
Q0030	PMO SIDE DUMMY L	GH72-08210A	
Q0031	PMO SIDE DUMMY R	GH72-08209A	
Q0032	PMO DUAL WINDOW	GH72-08492A	
Q0044	SUB LCD	GH07-00447A	
Q0052	SCREW-MACHINE;PH,+ ,M1.4,L5	6001-001633	
Q0054	SCREW-MACHINE;PH(P12.5),+ ,M1.4	6001-001155	
Q0063	MPR F/LOWER SCREW CAP	GH74-05770A	
Q0064	BATTERY-600MA	GH43-00955A	
Q0065	BATTERY-800MAH	GH43-00956A	
Q0066	MEC-FOLDER BRACKET	GH75-03247A	

3. Cellular phone Exploded View (SGH-D100A)

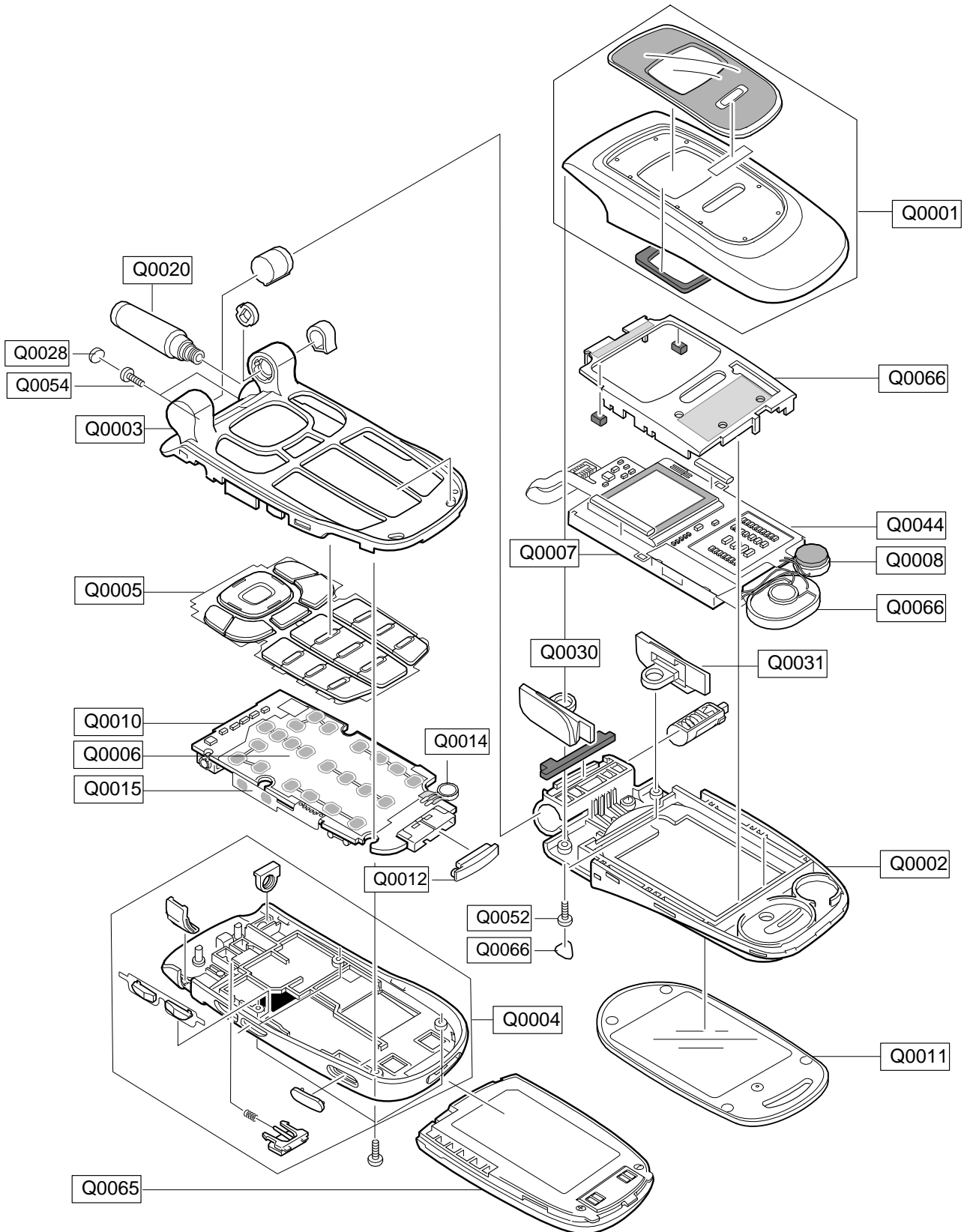

4.Cellular phone Parts list (SGH-D100A)

Location NO.		Description	SEC CODE	Remark
Q0001		MEC-F/ UPPER	GH75-04126A	
Q0002		MEC-F/ LOWER ASS'Y	GH75-04434A	
Q0003		MEC-FRONT COVER	GH75-03163A	
Q0004		MEC-REAR COVER	GH75-03166A	
Q0005		MEC-KEYPAD	GH75-03246A	
Q0006		UNIT-METAL DOME	GH59-00897A	
Q0007		LCD	GH07-00190A	
Q0008		MOTOR DC	GH31-00036A	
Q0009		MICRO SPEAKER	3001-001429	
Q0010		PBA MAIN	GH92-01486A	
Q0011		PMO WINDOW MAIN	GH72-06272A	
Q0012		RMO NEW IF CONN COVER	GH72-02504A	
Q0013		PMO NEW RF JACK COVER	GH72-09753A	
Q0014		MICROPHONE-ASSY	GH30-00033A	
Q0015		UNIT-VOL KEY	GH59-01025A	
Q0020		ANTENNA	GH42-00305A	
Q0028		MPR FRONT SCREW CAP	GH74-06303A	
Q0030		PMO SIDE DUMMY L	GH72-08210A	
Q0031		PMO SIDE DUMMY R	GH72-08209A	
Q0044		SUB LCD	GH07-00447A	
Q0052		SCREW-MACHINE;PH,+ ,M1.4,L5	6001-001633	
Q0054		SCREW-MACHINE;PH(P12.5),+ ,M1.4	6001-001155	
Q0063		MPR F/LOWER SCREW CAP	GH74-05770A	
Q0064		BATTERY-600MA	GH43-00955A	
Q0065		BATTERY-800MAH	GH43-00956A	
Q0066		MEC-FOLDER BRACKET	GH75-04127A	

5.. Test Jig [GH80-00865A]



3-1. RF Test Cable
[GH39-00182A]



3-2. Test Cable
[GH39-00127A]



3-3. Serial Cable



3-4. Power Supply Cable



3-5. DATA CABLE
[GH39-00159A]



3-6. TA
[GH44-00184A]



4. SGH-D100/D100A MAIN Electrical Parts List

SEC Code	Design LOC
GH71-00734A	ANT1001
2203-000995	C1003,C904
2203-000233	C1004,C1007,C1010
2203-002677	C1005,C1006,C1008
2203-002677	C1009,C1012,C1013
2203-000812	C101,C1014,C1016
2703-002207	C1015
2404-001151	C1017,C1021,C420
2203-000438	C1018,C416,C425,C426
2203-000812	C1019,C1020,C104
2203-005061	C102,C224,C225,C301
2203-005446	C1022
2203-001598	C103,C114
2203-000278	C1039
2203-000812	C105,C305,C906
2404-001105	C106
2404-001268	C107
2203-005482	C108
2203-005065	C110,C116,C117
2203-006053	C112
2203-001652	C113
2203-000438	C115,C612
2203-000233	C118,C428,C801
2203-005682	C201,C202,C203,C204
2203-005682	C205,C206,C207,C208
2203-005682	C209,C210,C211,C212
2203-005682	C213,C214,C215,C216
2203-005682	C217
2203-006113	C218,C219,C220,C221
2203-006257	C222
2203-005509	C223,C501,C502,C503
2203-005061	C302,C303,C304,C402
2203-000359	C401
2203-001405	C403,C609,C905
2203-005061	C404,C409,C417,C505
2404-001086	C405,C413
2203-000885	C408

SEC Code	Design LOC
2203-005065	C410,C423,C705,C109
2203-001412	C415
2203-001239	C429
2203-005509	C504
2203-000254	C506,C603,C604
2203-005496	C601,C602,C704
2203-000254	C605,C606,C611,C707
2203-005480	C607,C708,C709
2203-000679	C610
2203-000628	C613,C615
2203-005482	C614
2203-005393	C703
2203-005061	C706
2203-000254	C710,C711,C712,C804
2203-000233	C802,C803
2203-000254	C805,C806,C807
3709-001229	CN101
3711-005078	CN201
3710-001673	CN300
3722-001880	CN401
2909-001191	F1001
2904-001410	F1002
3705-001287	F1003
2703-002485	L1003
2703-002484	L1004
2703-002608	L1006
2703-002170	L1007
2203-005234	L1008
2703-002200	L1009
2703-001513	L402,L403
0601-001790	LED201,LED202,LED203
0601-001790	LED204,LED205,LED207
0601-001790	LED208,LED210,LED211
0601-001790	LED212,LED213,LED214
0601-001790	LED215,LED216
0604-001261	LED217
4302-001130	M101

SEC Code	Design LOC
2801-004025	OSC601
2809-001260	OSC801
0502-001201	Q101
0506-001052	Q102
0504-000168	Q103,Q104
0501-000225	Q401
2007-001288	R1001,R1005
2007-001307	R1002,R1006
2007-007008	R1003,R1004,R1007
2007-007008	R1008
2007-000162	R1009,R402,R701
2007-000171	R101,R1010
2007-000171	R1012,R1014
2007-000070	R1015
2007-007139	R103
2007-001323	R104
2007-000171	R105,R107,R108
2007-000758	R106
2007-000171	R109,R202,R203,R204
2007-001319	R111
2007-000148	R112,R408,R416,R423
2007-000171	R205,R206,R208,R209
2007-000171	R211,R212,R213,R214
2007-000171	R215,R216,R217,R412
2007-001291	R218
2007-000157	R301,R302,R303,R601
2007-000140	R304,R305,R306,R307
2007-000140	R308,R309,R310,R312
2007-000140	R313,R414,R420,R314
2007-000140	R315
2007-000172	R401,R403,R504
2007-000164	R404
2007-000161	R405
2007-000775	R406
2007-000159	R407,R411,R418
2007-001325	R410
2007-000141	R413,R415

SEC Code	Design LOC
2007-001333	R419
2007-000171	R421
2007-000160	R503
2007-008579	R603,R604,R605,R606
2007-008579	R607,R608,R609,R611
2007-008579	R612,R613,R614,R615
2007-008579	R616,R617,R618
2007-007200	R702,R703
2007-000162	R704,R705
2007-000172	R801,R602
2007-000137	R802
2007-001313	R803
2007-000138	R804
2007-000171	R805
1201-001889	U1001
1205-002433	U1002
2007-008579	U1003
2007-000162	U1004
2007-007142	U1005,R102,R110
2007-000170	U1006
2007-007308	U1007,U1008
2007-000157	U1009
1203-002127	U101
1203-002902	U102
1009-001010	U202
1001-001183	U401
1204-002161	U402
1109-001278	U500
GH09-00025A	U601
1209-001219	U602
1204-001984	U701
0504-001042	U702,U703,U704
1405-001019	V301
1405-001082	V401
0406-001150	ZD201,ZD202,ZD203
0406-001084	ZD301,ZD302,ZD303
0406-001152	ZD304

SGH-D100/D100A Electrical Parts List

SEC Code	Design LOC
0403-001427	ZD305
0406-001150	ZD402,ZD403,ZD404

5. SGH-D100/D100A Block Diagrams

1. RF Solution Block Diagram

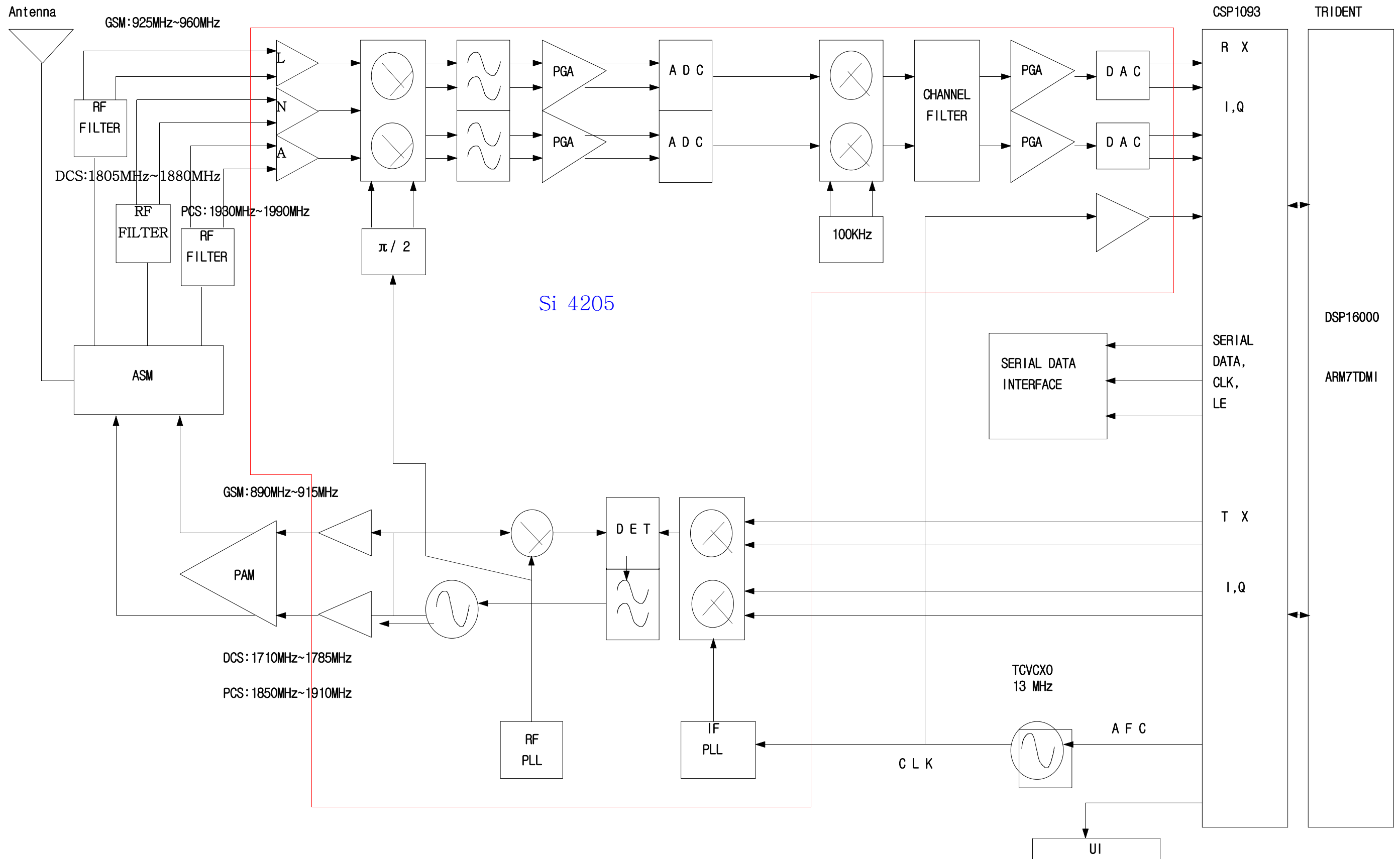

2. Base Band Solution Block Diagram

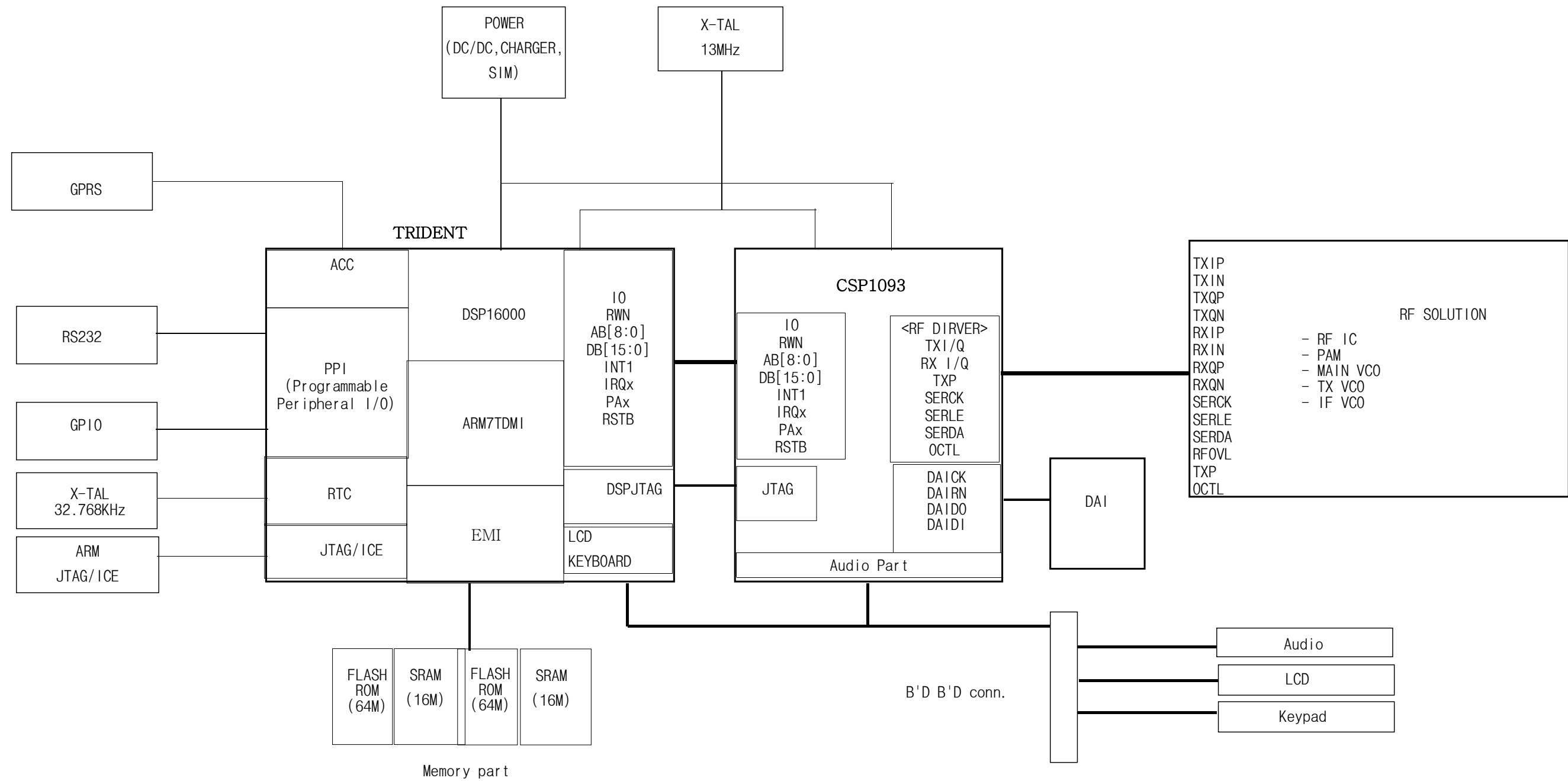

2. Bottom Diagram

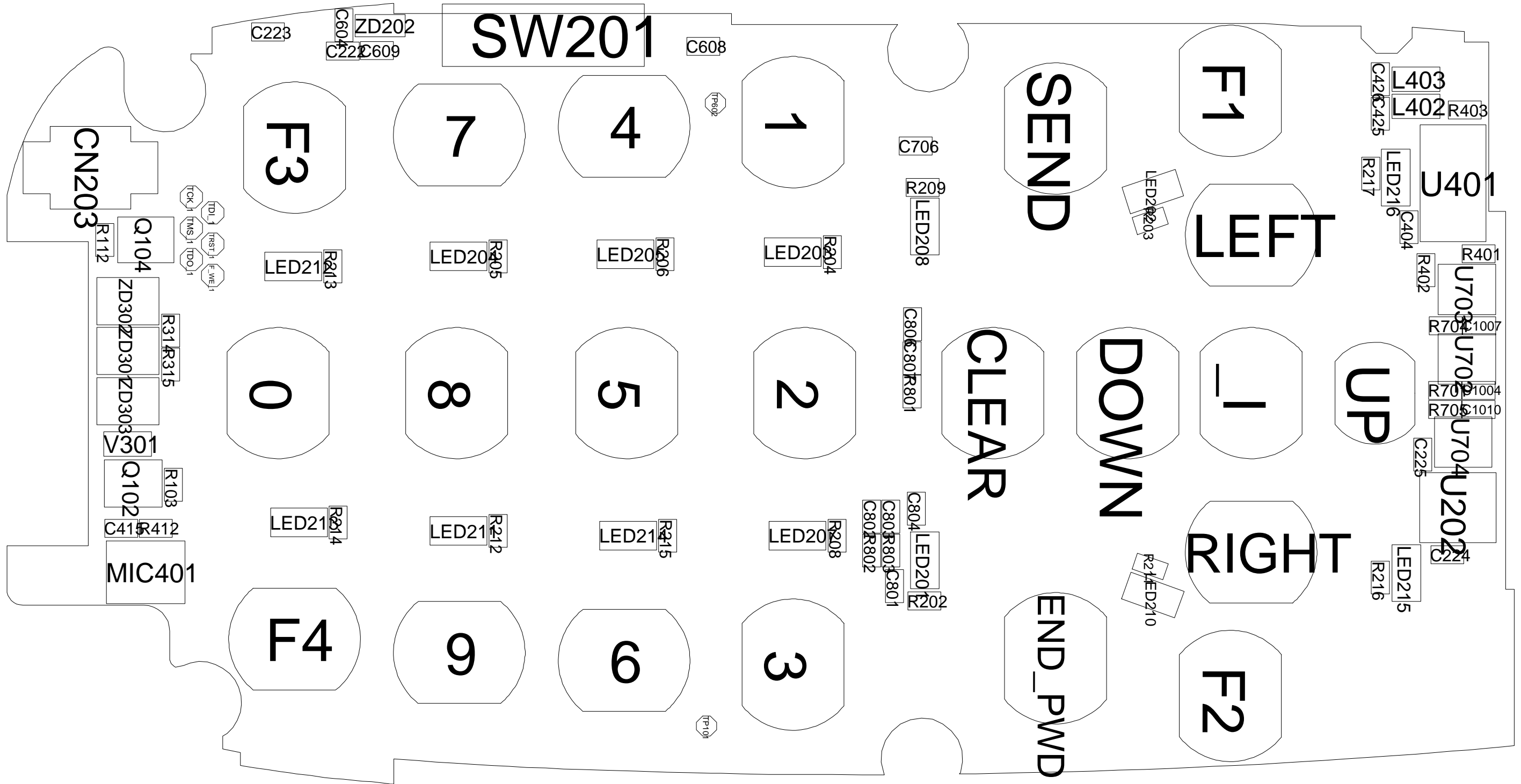



ELECTRONICS

© Samsung Electronics Co.,Ltd. Apl. 2004
Printed in Korea.

This Service Manual is a property of Samsung Electronics Co.,Ltd.
Any unauthorized use of Manual can be punished under applicable
international and/or domestic law.

Code No.: GH68-04203A
BASIC.