

**SAMSUNG**

GSM TELEPHONE  
SGH-C230

# ***SERVICE*** *Manual*

GSM TELEPHONE



CONTENTS

1. Specification
2. Circuit Description
3. Exploded Views and Parts List
4. Electrical Parts List
5. Block Diagrams
6. PCB Diagrams
7. Flow Chart of Troubleshooting

**SAMSUNG  
ELECTRONICS**



This Service Manual is a property of Samsung Electronics Co.,Ltd.  
Any unauthorized use of Manual can be punished under applicable  
international and/or domestic law.

Samsung Electronics Co.,Ltd. MAY. 2005  
Printed in Korea.

Code No.: GH68-07224A  
BASIC.

---

# 1. Specification

---

## 1-1. GSM General Specification

	<b>EGSM 900 Phase 2</b>	<b>DCS 1800 Phase 1</b>	<b>PCS 1900 Phase 1</b>
Freq. Band[MHz] Uplink/Downlink	880~915 925~960	1710~1785 1805~1880	1850~1910 1930~1960
ARFCN range	0~124 & 975~1023	512~885	512~810
Tx/Rx spacing	45MHz	95MHz	80MHz
Mod. Bit rate/ Bit Period	270.833kbps 3.692us	270.833kbps 3.692us	270.833kbps 3.692us
Time Slot Period/Frame Period	576.9us 4.615ms	576.9us 4.615ms	576.9us 4.615ms
Modulation	0.3GMSK	0.3GMSK	0.3GMSK
MS Power	33dBm~5dBm	30dBm~0dBm	30dBm~0dBm
Power Class	5pcl ~ 19pcl	0pcl ~ 15pcl	0pcl ~ 15pcl
Sensitivity	-102dBm	-100dBm	-100dBm
TDMA Mux	8	8	8
Cell Radius	35Km	2Km	2Km
Operating Temperature	-20°C ~ +50°C		



---

## 2. Circuit Description

---

### 2-1. SGH-C230 RF Circuit Description

#### 2-1-1. RX PART

—ASM(F100) Switching Tx, Rx path for GSM900, DCS1800 and PCS1900 by logic controlling.

—ASM Control Logic Truth Table

	VC1	VC2	VC3
EGSM TX	H	L	L
DCS/PCS TX	L	H	L
PCS_RX	L	L	H

—Saw FILTER

To convert Electromagnetic Field Wave to Acoustic Wave and then pass the specific frequency band.

- GSM FILTER (F102) For filtering the frequency band between 925 and 960 MHz.
- DCS FILTER (F102) For filtering the frequency band between 1805 and 1880 MHz
- PCS FILTER (F101) For filtering the frequency band between 1930 and 1990 MHz.

—Crystal (U102)

To generate the 26MHz reference clock to drive the logic and RF.

After additional process, the reference clock applies to the U801 Rx IQ demodulator and Tx IQ modulator.

The oscillator for RX IQ demodulator and Tx modulator are controlled by serial data to select channel and use fast lock mode for GPRS high class operation.

—Si4210 (U100)

The receive section integrates four differential-input low noise amplifiers LNAs supporting the GSM850, EGSM900, DCS1800 and PCS1900 bands. The LNA inputs are matched to the 150 ohm balanced-output SAW filters through external LC matching network.

A quadrature Image-reject mixer downconverts the RF signal to a 200 KHz intermediate frequency(IF). The mixer output is amplified with an analog programmable gain amplifier(PGA) that is controlled with the AGAIN. The quadrature IF is digitized with high resolution analog-to-digital converts (ADC).

The ADC output is downconverted to baseband with a digital quadrature LO signal. Digital decimation and FIR filters perform digital filtering and remove ADC quantization noise, blockers and reference interferers.

After filtering, the digital output is scaled with a digital PGA, which is controlled with the DGAIN. DACs drive a differential I and Q analog signal onto the BIP, BIN, BQP and BQN pins to interface to standard analog-input baseband ICs.

## 2-1-2. TX PART

Baseband IQ signal fed into offset PLL, this function is included inside of U801 chip. The transmit section of U801 consist of an I/Q baseband upconverter, an offset phase-locked loop (OPLL) and two 50 ohm output buffers that can drive an external Power Amplifier(PA). Si4210 chip generates modulator signal which power level is about 1.5dBm and fed into Power Amplifier(U900). The PA output power and power ramping are well controlled by Auto Power Control circuit. We use offset PLL below.

Modulation Spectrum	200kHz offset 30 kHz bandwidth	GSM	-35dBc
		DCS	-35dBc
		PCS	-35dBc
	400kHz offset 30 kHz bandwidth	GSM	-66dBc
		DCS	-65dBc
		PCS	-66dBc
	600kHz ~ 1.8MHz offset 30 kHz bandwidth	GSM	-75dBc
		DCS	-68dBc
		PCS	-75dBc

## 2-2. Baseband Circuit description of SGH-C230

### 2-2-1. CSP2200B1

#### — Power Management

Seven low-dropout regulators designed specifically for GSM applications power the terminal and help ensure optimal system performance and long battery life. A programmable LDO provides support for 1.8V, 3.0V SIMs, while a self-resetting, electronically fused switch supplies power to external accessories. Ancillary support functions, such as two LED drivers and two call-alert drivers, aid in reducing both board area and system complexity. A four-wire serial interface unit(SIU) provides access to control and configuration registers. This interface gives a microprocessor full control of the CSP2200B1 and enables system designers to maximize both standby and talk times. Error reporting is provided via an interrupt signal and status register. Supervisory functions, including a reset generator, an input voltage monitor, and a thermal monitor, support reliable system design. These functions work together to ensure proper system behavior during start-up or in the event of a fault condition(low microprocessor voltage, insufficient battery energy, or excessive die temperature).

#### — Battery Charge Management

A battery charge management block, incorporating an internal PMOS switch, and an 8-bit ADC, provides fast, efficient charging of single-cell Li-Ion battery. Used in conjunction with a current-limited voltage source, this block safely conditions near-dead cells and provides the option of having fast-charge and top-off controlled internally or by the system's microprocessor.

### — Backlight LED Driver

The backlight LED driver is a low-side, programmable current source designed to control the brightness of the keyboard illumination. LED1\_DRV is controlled via LED1\_[0:2] and can be programmed to sink from 15mA to 60mA in 7.5mA steps. LED2\_DRV is controlled via LED2\_[0:2] and can be programmed to sink from 5mA to 40mA in 5mA steps. Both LED drivers are capable of sinking their maximum output current at a worst-case maximum output voltage of 0.6V. For efficient use, the LEDs is connected between the battery and the LED\_DRV output.

### — Vibrator Motor Driver

The vibrator motor driver is a independent voltage regulator to drive a small dc motor that silently alerts the user of an incoming call. The driver is a 3.3V constant source while sinking up to 140mA and controlled by enable signal of main chip. For efficient use and safety, the vibrator motor should be connected between the regulator output and the ground.

## 2-2-2 Connector

### — JTAG Connector

Trident has two JTAG ports which are for ARM core and DSP core(DSP16000). So this system has two port connector for these ports. Pins' initials for ARM core are 'CP\_' and pins' initials for DSP core are 'DSP\_'. CP\_TDI and DSP\_TDI signal are used for input of data. CP\_TDO and DSP\_TDO signals are used for the output of the data. CP\_TCK and DSP\_TCK signals are used for clock because JTAG communication is a synchronous. CP\_TMS and DSP\_TMS signals are test mode signals. The difference between these is the RESET\_INT signal which is for ARM core RESET.

### — Keypad connector

This is consisted of key interface pins in the trident, KEY\_ROW[0~4] and KEY\_COL[0~4]. These signals compose the matrix. Result of matrix informs the key status to key interface in the trident. Some pins are connected to varistor for ESD protection. And power on/off key is seperated from the matrix.

So power on/off signal is connected with CSP2200 to enable CSP2200.

Nine key LED use the +VBATT supply voltage. These are connected to BACKLIGHT signal in the CSP2200.

This signal enables LEDs with current control.

### — EMI Filtering

This system uses the EMI Filter to reduce noise from LCD part. Some control signals are connected to LCD without EMI filtering.

### 2-2-3. IF connector

It is 24-pin connector, and separated into two parts. One is a power supply part for main system. And the other is designed to use SDS, DEBUG, DLC-DETECT, JIG\_ON, VEXT, VTEST, VF, and GND. They connected to power supply IC, microprocessor and signal processor IC.

### 2-2-4. Audio

AOUTAP, AOUTAN from CSP2200 is connected to the speaker via analog switch. AOUTBP and AOUTBN are connected to the ear-mic speaker via ear-jack. MICIN and MICOUT are connected to the main MIC. And AUXIN and AUXOUT are connected to the Ear-mic.

YMU762MA3 is a LSI for portable telephone that is capable of playing high quality music by utilizing FM synthesizer and ADPCM decoder that are included in this device.

As a synthesis, YMU762MA3 is equipped 16 voices with different tones. Since the device is capable of simultaneously generating up to synchronous with the play of the FM synthesizer, various sampled voices can be used as sound effects. Since the play data of YMU762MA3 are interpreted at anytime through FIFO, the length of the data(playing period) is not limited, so the device can flexibly support application such as incoming call melody music distribution service. The hardware sequencer built in this device allows playing of the complex music without giving excessive load to the CPU of the portable telephones. Moreover, the registers of the FM synthesizer can be operated directly for real time sound generation, allowing, for example, utilization of various sound effects when using the game software installed in the portable telephone.

YMU762 includes a speaker amplifier with high ripple removal rate whose maximum output is 550mW (SPVDD=3.6V).

The device is also equipped with conventional function including a vibartor and a circuit for controlling LEDs synchronously with music.

For the headphone, it is provided with a stereophonic output terminal.

For the purpose of enabling YMU762MA3 to demonstrate its full capabilities, Yamaha purpose to use "SMAF:Synthetic music Mobile Application Format" as a data distribution format that is compatible with multimedia.

Since the SMAF takes a structure that sets importance on the synchronization between sound and images, various contents can be written into it including incoming call melody with words that can be used for training karaoke, and commercial channel that combines texts, images and sounds, and others. The hardware sequencer of YMU762MA3 directly interprets and plays blocks relevant to synthesis (playing music and reproducing ADPCM with FM synthesizer) that are included in data distributed in SMAF.

### 2-2-5. Memory

This system uses SHARP's memory, LRS18B0.

It is consisted of 256M bits flash memory and 64M bits SCRAM. It has 16 bit data line, D[0~15] which is connected to trident, LCD or CSP2200. It has 23 bit address lines, A[1~23]. They are also connected. CP\_CSROMEN signal, chip select signal in the trident, enable flash memories. They use supply voltages, VCCD and VCC\_1.8A.



During writing process, CP\_WEN is low and it enables writing process to flash memory and SCRAM. During reading process, CP\_OEN is low and it outputs information which is located at the address from the trident in the flash memory or SCRAM to data lines. Each chip select signal in the trident selects flash memory or SCRAM. Reading or writing procedure is processed after CP\_WEN or CP\_OEN is enabled. Memories use FLASH\_RESET, which is a buffered signal of RESET from CSP2200, for ESD protection. A[0] signal enables lower byte of SCRAM and UPPER\_BYTE signal enables higher byte of SCRAM.

## 2-2-6. Trident

Trident is consisted of ARM core and DSP core. It has 20K\*16bits RAM 144K\*16bits ROM in the DSP. It has 4K\*32bits ROM and 2K\*32bits RAM in the ARM core. DSP is consisted of timer, one bit input/output unit(BIO), JTAG, EMI and HDS(Hardware Development System). ARM core is consisted of EMI, PIC(Programmable Interrupt Controller), reset/power/clock unit, DMA controller, TIC(Test Interface Controller), peripheral bridge, PPI, SSI(Synchronous Serial Interface), ACCs(Asynchronous communications controllers), timer, ADC, RTC(Real-Time Clock) and keyboard interface. DSP\_AB[0~8], address lines of DSP core and DSP\_DB[0~15], data lines of DSP core are connected to CSP2200. A[0~20], address lines of ARM core and D[0~15], data lines of ARM core are connected to memory, LCD and YMU762. ICP(Interprocessor Communication Port) controls the communication between ARM core and DSP core. CSROMEN, CSRAMEN and CS1N to CS4N in the ARM core are connected to each memory. WEN and OEN control the process of memory. External IRQ(Interrupt ReQuest) signals from each units, such as, YMU, Ear-jack, Ear-mic and CSP1093, need the compatible process.

Some PPI pins has many special functions. CP\_KB[0~9] receive the status from key FPCB and are used for the communications using data link cable(DEBUG\_DTR/RTS/TXD/RXD/CTS/DSR).

And UP\_CS/SCLK/SDI, control signals for CSP2200 are outputted through PPI pins. It has signal port for charging(CHG\_DET), SIM\_RESET and FLIP\_SNS with which we know open/closed status of folder. It has JTAG control pins(TDI/TDO/TCK) for ARM core and DSP core. It receives 13MHz clock in CKI pin from external TCXO and receives 32.768KHz clock from X1RTC. ADC(Analog to Digital Converter) part receives the status of temperature, battery type and battery voltage. And control signals(DSP\_INT, DSP\_IO and DSP\_RWN) for DSP core are used. It enables main LCD with DSP IP pins.

## 2-2-7. CSP2200

CSP2200 is integrated the timing and control functions for GSM 2+ mobile application with the ADC and DAC functions, and power management block. The CSP2200 interfaces to the trident, via a 16-bit parallel interface. It serves as the interface that connects a DSP to the RF circuitry in a GSM 2+ mobile telephone. DSP can load 148 bits of burst data into CSP2200's internal register, and program CSP2200's event timing and control register with the exact time to send the burst. When the timing portion of the event timing and control register matches the internal quarter-bit counter and internal frame counter, the 148 bits in the internal register are GMSK modulated according to GSM 2+ standards. The resulting phase information is translated into I and Q differential output voltages that can be connected directly to an RF modulator at the TXOP and TXON pins. The DSP is notified when the transmission is completed. For receiving baseband data, a DSP can program CSP2200's event timing and control register with the exact time to start receiving I and Q samples through TXIP and TXIN pins.

When that time is reached, the control portion of the event timing and control register will start the baseband receive section converting I and Q sample pairs. The samples are stored in a double-buffered register until the register contains 32 sample pairs. CSP2200 then notifies the DSP which has sample time to read the information out before the next 32 sample pairs are stored. The voice band ADC converter issues an interrupt to the DSP whenever it finishes converting a 16-bit PCM word. The DSP then reads the new input sample and simultaneously loads the voice band output DAC converter with a new PCM output word. The voice band output can be connected directly to a speaker via AOUTAN and AOUTAP pins and be connected to a Ear-mic speaker via AOUTBN and AOUTBP pins.

There are 7 LDOs which are power sources of microprocessor, LCD, etc. These 7 LDOs output are programmable.

---

### 3. Exploded View and Parts List

---

#### 3-1. Exploded View

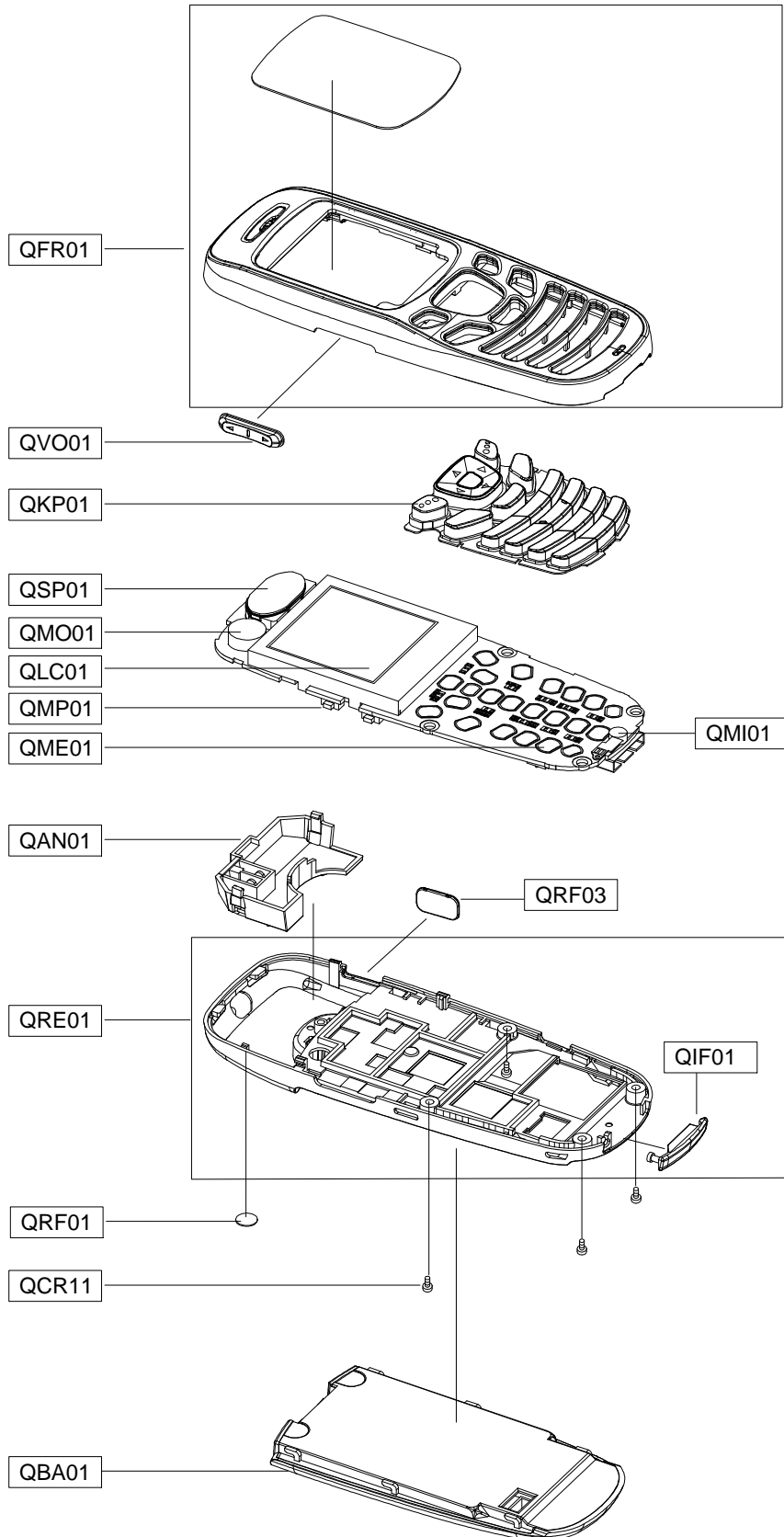

## 3-2. Parts List

Location NO.		Description	SEC CODE	Remark
QFR01		MEC-FRONT CASE	GH75-06758A	
QVO01		MEC-SIDE KEY	GH75-04859A	
QKP01		MEC-KEYPAD	GH75-06834B	
QSP01		SPEAKER	3001-001760	
QMO01		MOTOR DC	GH31-00163A	
QLC01		LCD-SGHC210 MAIN	GH07-00701A	
QMP01		MAIN PBA	GH92-02137A	
QME01		UNIT-METAL DOME	GH59-02124A	
QMI01		MICROPHONE-ASSY	GH30-00187A	
QAN01		ANTENNA	GH42-00551A	
QRF03		PMO-EAR COVER	GH72-21155A	
QRE01		MEC-REAR CASE	GH75-06760A	
	QIF01	PMO-IF COVER	GH72-21397A	
QCR11		SCREW-MACHINE	6001-001654	
QRF01		MPR-RF SHEET	GH74-14935A	
QBA01		BATTERY	GH43-01803A	

Description	SEC CODE
BAG PE;LDPE,T0.05,W80,L180,TRP,-,-	6902-00634
ADAPTOR - TAD;TAD137USE,SGH - E800,AC/DC	GH44 - 00770A
UNIT - EARPHONE;SGH - i270,EM - SS550E - ST,	GH59 - 01543A
LABEL(P) - WATER SOAK;SCH - X110,NORGE,1	GH68 - 02026A
MANUAL - USE;SGH - C230,XSP,ENGLISH,SIPL	GH68 - 06943A
LABEL(R) - MAIN(EU);SGH - C230,EU,POLYES	GH68 - 07006A
BOX(P) - UINIT(SEA);SGH - C230,SC300 + S12	GH69 - 02620A
CUSHION - CASE(1 - 2);SGH - C230,PULP,T0.8	GH69 - 02914A
MPR - ESD TAPE;SGH - C200,3M 851,7X5,-,-	GH74 - 05583A
MPR - MAIN WINDOW BOHO VI;SGH - C207,STA	GH74 - 09827A
MPR - MAIN WINDOW BOHO;SGH - C200,S.T 55	GH74 - 11299A
MPR - MAIN WINDOW BOHO;SGH - C200,ST 555	GH74 - 11636A
MPR - LDI SPONGE;SGH - C230,PSR PORON,31	GH74 - 15399A

### 3-3. Test Jig (GH80-00865A)



3-3-1. RF Test Cable  
(GH39-00283A)



3-3-2. Test Cable  
(GH39-00127A)



3-3-3. Serial Cable



3-3-4. Power Supply Cable



3-3-5. DATA CABLE  
(GH39-00143B)



3-3-6. TA  
(GH44-00184A)



## 4. Electrical Parts List

Design LOC	Description	SEC CODE
C103	C-CER,CHIP	2203-000438
C104	C-CER,CHIP	2203-000438
C105	C-CER,CHIP	2203-000995
C108	C-CER,CHIP	2203-002668
C109	C-TA,CHIP	2404-001397
C110	C-CER,CHIP	2203-006090
C111	C-CER,CHIP	2203-002668
C112	C-CER,CHIP	2203-005050
C113	C-CER,CHIP	2203-000530
C114	C-CER,CHIP	2203-001432
C115	C-CER,CHIP	2203-000438
C116	C-CER,CHIP	2203-000995
C117	C-CER,CHIP	2203-000254
C120	C-CER,CHIP	2203-005482
C121	C-CER,CHIP	2203-000854
C122	C-CER,CHIP	2203-000278
C123	C-CER,CHIP	2203-000233
C124	C-CER,CHIP	2203-002677
C125	C-CER,CHIP	2203-005450
C126	C-CER,CHIP	2203-002677
C127	C-CER,CHIP	2203-000278
C128	C-CER,CHIP	2203-005234
C129	C-CER,CHIP	2203-005234
C130	C-CER,CHIP	2203-001017
C131	C-CER,CHIP	2203-000696
C132	C-CER,CHIP	2203-000696
C133	C-CER,CHIP	2203-005482
C134	C-CER,CHIP	2203-000386
C135	C-CER,CHIP	2203-001412
C136	C-CER,CHIP	2203-005482
C137	C-CER,CHIP	2203-001072
C200	C-CER,CHIP	2203-000254
C201	C-CER,CHIP	2203-000254
C202	C-CER,CHIP	2203-000254
C203	C-CER,CHIP	2203-000254
C204	C-CER,CHIP	2203-005496
C205	C-CER,CHIP	2203-005061
C206	C-CER,CHIP	2203-000679
C207	C-CER,CHIP	2203-000254
C208	C-CER,CHIP	2203-001405
C209	C-CER,CHIP	2203-000254
C210	C-CER,CHIP	2203-000254
C211	C-CER,CHIP	2203-000254
C212	C-CER,CHIP	2203-000254
C213	C-CER,CHIP	2203-005496
C214	C-CER,CHIP	2203-000254
C216	C-CER,CHIP	2203-000330
C217	C-CER,CHIP	2203-000330
C218	C-CER,CHIP	2203-006438
C300	C-CER,CHIP	2203-000254

Electrical Parts List

Design LOC	Description	SEC CODE
C301	C-CER,CHIP	2203-001072
C302	C-CER,CHIP	2203-005482
C303	C-CER,CHIP	2203-006093
C304	C-CER,CHIP	2203-000812
C305	C-CER,CHIP	2203-000812
C306	C-CER,CHIP	2203-000812
C307	C-CER,CHIP	2203-005061
C308	C-CER,CHIP	2203-001598
C309	C-CER,CHIP	2203-000233
C310	C-TA,CHIP	2404-001240
C311	C-CER,CHIP	2203-006053
C312	C-CER,CHIP	2203-006053
C313	C-CER,CHIP	2203-006053
C314	C-CER,CHIP	2203-006053
C315	C-CER,CHIP	2203-006053
C316	C-CER,CHIP	2203-001598
C317	C-CER,CHIP	2203-000254
C318	C-CER,CHIP	2203-005061
C322	C-CER,CHIP	2203-005065
C324	C-TA,CHIP	2404-001268
C325	C-CER,CHIP	2203-000233
C326	C-TA,CHIP	2404-001268
C327	C-CER,CHIP	2203-006257
C401	C-CER,CHIP	2203-000812
C402	C-CER,CHIP	2203-000812
C403	C-CER,CHIP	2203-005496
C404	C-CER,CHIP	2203-000995
C405	C-CER,CHIP	2203-000628
C406	C-CER,CHIP	2203-000425
C407	C-CER,CHIP	2203-005496
C409	C-CER,CHIP	2203-000812
C410	C-TA,CHIP	2404-001305
C411	C-CER,CHIP	2203-000233
C412	C-CER,CHIP	2203-005496
C414	C-CER,CHIP	2203-000995
C415	C-CER,CHIP	2203-000278
C416	C-CER,CHIP	2203-005496
C418	C-CER,CHIP	2203-000254
C419	C-CER,CHIP	2203-006137
C420	C-CER,CHIP	2203-005061
C421	C-TA,CHIP	2404-001380
C422	C-TA,CHIP	2404-001380
C501	C-CER,CHIP	2203-005480
C502	C-CER,CHIP	2203-000254
C503	C-CER,CHIP	2203-005480
C504	C-CER,CHIP	2203-000995
C505	C-CER,CHIP	2203-000679
C506	C-CER,CHIP	2203-005480
C507	C-CER,CHIP	2203-005065
C508	C-CER,CHIP	2203-005061



Design LOC	Description	SEC CODE
C509	C-TA,CHIP	2404-001105
C511	C-CER,CHIP	2203-006093
C514	C-CER,CHIP	2203-006257
C515	C-CER,CHIP	2203-005480
C517	C-TA,CHIP	2404-001240
C519	C-CER,CHIP	2203-005496
C520	C-CER,CHIP	2203-006257
C521	C-CER,CHIP	2203-006090
C522	C-CER,CHIP	2203-006257
C523	C-CER,CHIP	2203-005496
C527	C-CER,CHIP	2203-002687
C531	C-TA,CHIP	2404-001268
C532	C-CER,CHIP	2203-005061
C534	C-CER,CHIP	2203-005496
C538	C-CER,CHIP	2203-005061
C539	C-CER,CHIP	2203-000585
C542	C-CER,CHIP	2203-006208
C543	C-CER,CHIP	2203-006190
C544	C-CER,CHIP	2203-000438
C545	C-CER,CHIP	2203-005061
C546	C-CER,CHIP	2203-006562
C548	C-CER,CHIP	2203-006257
C549	C-TA,CHIP	2404-001088
C550	C-CER,CHIP	2203-006348
C551	C-CER,CHIP	2203-005482
C552	C-CER,CHIP	2203-000233
C600	C-CER,CHIP	2203-005061
C601	C-CER,CHIP	2203-005061
C602	C-CER,CHIP	2203-000233
C603	C-CER,CHIP	2203-000254
C700	C-CER,CHIP	2203-000438
C701	C-CER,CHIP	2203-000233
C703	C-CER,CHIP	2203-006348
C704	C-CER,CHIP	2203-006562
C705	C-TA,CHIP	2404-001268
C706	C-CER,CHIP	2203-000854
C710	C-NETWORK	2503-001053
C711	C-NETWORK	2503-001041
C712	C-NETWORK	2503-001041
C713	C-NETWORK	2503-001053
C714	C-NETWORK	2503-001053
C715	C-NETWORK	2503-001053
C716	C-NETWORK	2503-001053
CN100	CONNECTOR-COAXIAL	3705-001347
CN300	CONNECTOR-CARD EDGE	3709-001229
CN400	JACK-EAR PHONE	3722-002356
CN701	CONNECTOR-INTERFACE	3710-001611
CN702	CONNECTOR-HEADER	3711-005558
D500	DIODE-ARRAY	0407-001002
F100	DUPLEXER-ASM	2911-000002

Electrical Parts List

Design LOC	Description	SEC CODE
F101	FILTER-SAW	2904-001480
F102	FILTER-SAW	2904-001523
L101	INDUCTOR-SMD	2703-002367
L102	INDUCTOR-SMD	2703-002199
L103	INDUCTOR-SMD	2703-002205
L105	INDUCTOR-SMD	2703-002544
L106	INDUCTOR-SMD	2703-002205
L107	INDUCTOR-SMD	2703-002544
L108	INDUCTOR-SMD	2703-002199
L109	INDUCTOR-SMD	2703-002558
L110	INDUCTOR-SMD	2703-002170
L112	INDUCTOR-SMD	2703-002269
L401	INDUCTOR-SMD	2703-002202
L402	INDUCTOR-SMD	2703-002202
L403	INDUCTOR-SMD	2703-001231
L501	INDUCTOR-SMD	2703-001673
L503	INDUCTOR-SMD	2703-002206
L701	INDUCTOR-SMD	2703-002339
L702	BEAD-SMD	3301-001659
LED601	LED	0601-002020
LED602	LED	0601-002020
LED603	LED	0601-002020
LED604	LED	0601-002020
LED605	LED	0601-002020
LED606	LED	0601-002020
LED607	LED	0601-002020
LED608	LED	0601-002020
LED609	LED	0601-002020
LED610	LED	0601-002020
OSC200	CRYSTAL-SMD	2801-003856
PCB	PCB-SGHC230PCB	GH41-00865A
Q300	TR-DIGITAL	0504-000168
R100	R-CHIP	2007-000171
R101	R-CHIP	2007-001313
R102	R-CHIP	2007-001298
R103	R-CHIP	2007-000171
R104	R-CHIP	2007-002797
R105	R-CHIP	2007-000148
R106	R-CHIP	2007-001308
R107	R-CHIP	2007-000171
R200	R-CHIP	2007-000171
R201	R-CHIP	2007-000157
R202	R-CHIP	2007-000172
R203	R-CHIP	2007-000157
R204	R-CHIP	2007-000171
R205	R-CHIP	2007-000171
R206	R-CHIP	2007-007480
R207	R-CHIP	2007-000157
R208	R-CHIP	2007-007538
R209	R-CHIP	2007-000171

Design LOC	Description	SEC CODE
R210	R-CHIP	2007-000171
R211	R-CHIP	2007-007142
R212	R-CHIP	2007-000140
R213	R-CHIP	2007-000171
R214	R-CHIP	2007-000171
R215	R-CHIP	2007-007308
R216	R-CHIP	2007-000162
R217	R-CHIP	2007-007308
R218	R-CHIP	2007-000171
R219	R-CHIP	2007-000171
R220	R-CHIP	2007-000171
R221	R-CHIP	2007-000171
R222	R-CHIP	2007-000171
R223	R-CHIP	2007-000143
R224	R-CHIP	2007-000143
R225	R-CHIP	2007-000157
R226	R-CHIP	2007-000157
R300	R-CHIP	2007-000171
R301	R-CHIP	2007-001319
R302	R-CHIP	2007-000172
R303	R-CHIP	2007-000171
R304	R-CHIP	2007-000167
R310	R-CHIP	2007-007142
R311	R-CHIP	2007-008263
R312	R-CHIP	2007-000157
R400	R-CHIP	2007-007468
R401	R-CHIP	2007-007142
R402	R-CHIP	2007-000148
R403	R-CHIP	2007-007142
R404	R-CHIP	2007-007468
R405	R-CHIP	2007-001320
R406	R-CHIP	2007-000142
R407	R-CHIP	2007-001317
R408	R-CHIP	2007-000171
R409	R-CHIP	2007-000171
R410	R-CHIP	2007-001320
R411	R-CHIP	2007-000142
R412	R-CHIP	2007-007142
R413	R-CHIP	2007-007134
R414	R-CHIP	2007-007134
R415	R-CHIP	2007-007142
R416	R-CHIP	2007-007573
R417	R-CHIP	2007-007480
R418	R-CHIP	2007-001339
R419	R-CHIP	2007-000162
R420	R-CHIP	2007-000162
R421	R-CHIP	2007-000173
R422	R-CHIP	2007-000173
R423	R-CHIP	2007-000171
R424	R-CHIP	2007-000171

Electrical Parts List

Design LOC	Description	SEC CODE
R425	R-CHIP	2007-001317
R502	R-CHIP	2007-000171
R503	R-CHIP	2007-003001
R505	R-CHIP	2007-000171
R506	R-CHIP	2007-000162
R507	R-CHIP	2007-001291
R508	R-CHIP	2007-000171
R509	R-CHIP	2007-000162
R514	R-CHIP	2007-000171
R515	R-CHIP	2007-000146
R518	R-CHIP	2007-001319
R519	R-CHIP	2007-001325
R526	R-CHIP	2007-001291
R528	R-CHIP	2007-001291
R529	R-CHIP	2007-000171
R530	R-CHIP	2007-000171
R531	R-CHIP	2007-000171
R532	R-CHIP	2007-000171
R533	R-CHIP	2007-000171
R534	R-CHIP	2007-000171
R535	R-CHIP	2007-000171
R536	R-CHIP	2007-000171
R538	R-CHIP	2007-000171
R539	R-CHIP	2007-000775
R540	R-CHIP	2007-001325
R541	R-CHIP	2007-000171
R542	R-CHIP	2007-000171
R600	R-CHIP	2007-000174
R601	R-CHIP	2007-000174
R602	R-CHIP	2007-000174
R603	R-CHIP	2007-000174
R604	R-CHIP	2007-000174
R605	R-CHIP	2007-000174
R606	R-CHIP	2007-000174
R607	R-CHIP	2007-000174
R608	R-CHIP	2007-000174
R609	R-CHIP	2007-000174
R610	R-CHIP	2007-000172
R611	R-CHIP	2007-000171
R700	R-CHIP	2007-000171
R701	R-CHIP	2007-000171
R702	R-CHIP	2007-000171
R703	R-CHIP	2007-000171
R704	R-CHIP	2007-000140
R705	R-CHIP	2007-003001
R707	R-CHIP	2007-000566
R708	R-CHIP	2007-000566
R709	R-CHIP	2007-000566
R710	R-CHIP	2007-000566
R711	R-CHIP	2007-000566

Design LOC	Description	SEC CODE
R712	R-CHIP	2007-000140
R713	R-CHIP	2007-000140
R714	R-CHIP	2007-000140
R715	R-CHIP	2007-000140
R716	R-CHIP	2007-000140
R717	R-CHIP	2007-000140
R718	R-CHIP	2007-000140
R719	R-CHIP	2007-000140
R720	R-CHIP	2007-000140
R721	R-CHIP	2007-000140
R722	R-CHIP	2007-000153
R723	R-CHIP	2007-000171
R724	R-CHIP	2007-000140
R725	R-CHIP	2007-000162
R726	R-CHIP	2007-000140
R727	R-CHIP	2007-000140
TH200	THERMISTOR-NTC	1404-001221
U100	IC-TRANSCIEVER	1205-002683
U101	IC-POWER AMP	1201-002260
U102	CRYSTAL-SMD	2801-004426
U200	IC MICOM-SGHX480	GH09-00036A
U201	IC MICOM-SGHV100	GH09-00022A
U300	IC-POWER SUPERVISOR	1203-003304
U301	IC-BATTERY	1203-003109
U303	BATTERY-LI (2ND)	4302-001130
U401	IC-VOLTAGE COMP.	1202-001068
U402	IC-ANALOG SWITCH	1001-001261
U500	IC-DEMULATOR	1204-002398
U501	IC-AUDIO AMP	1201-002238
U504	PHOTO-IRDA	0604-001261
U505	IC-POSITIVE FIXED REG.	1203-002782
U506	IC-MELODY	1204-002161
U507	IC-ANALOG MULTIPLEX	1001-001306
U601	IC-MCP	1108-000010
U701	IC-CMOS LOGIC	0801-000796
U719	IC-DC/DC CONVERTER	1203-003674
V401	VARISTOR	1405-001082
V402	VARISTOR	1405-001082
V403	VARISTOR	1405-001082
V404	VARISTOR	1405-001082
V405	VARISTOR	1405-001082
V601	VARISTOR	1405-001082
V602	VARISTOR	1405-001082
V603	VARISTOR	1405-001082
V604	VARISTOR	1405-001082
V605	VARISTOR	1405-001082
V606	VARISTOR	1405-001082
V607	VARISTOR	1405-001082
V608	VARISTOR	1405-001082
V609	VARISTOR	1405-001082

Electrical Parts List

---

Design LOC	Description	SEC CODE
V610	VARISTOR	1405-001082
V611	VARISTOR	1405-001082
V612	VARISTOR	1405-001082
V701	VARISTOR	1405-001082
V702	VARISTOR	1405-001082
V703	VARISTOR	1405-001082
V704	VARISTOR	1405-001082
V705	VARISTOR	1405-001082
V706	VARISTOR	1405-001093
VOL_DN	SWITCH-TACT	3404-001152
VOL_UP	SWITCH-TACT	3404-001152
ZD501	DIODE-TVS	0406-001201
ZD502	DIODE-TVS	0406-001201
ZD600	DIODE-TVS	0406-001194
ZD601	VARISTOR	1405-001108
ZD602	VARISTOR	1405-001108
ZD603	VARISTOR	1405-001108
ZD701	DIODE-TVS	0406-001083
ZD702	DIODE-TVS	0406-001083
ZD703	DIODE-ZENER	0403-001387
ZD704	DIODE-ZENER	0403-001427

## 5. Block Diagrams

### 5-1. RF Solution Block Diagram

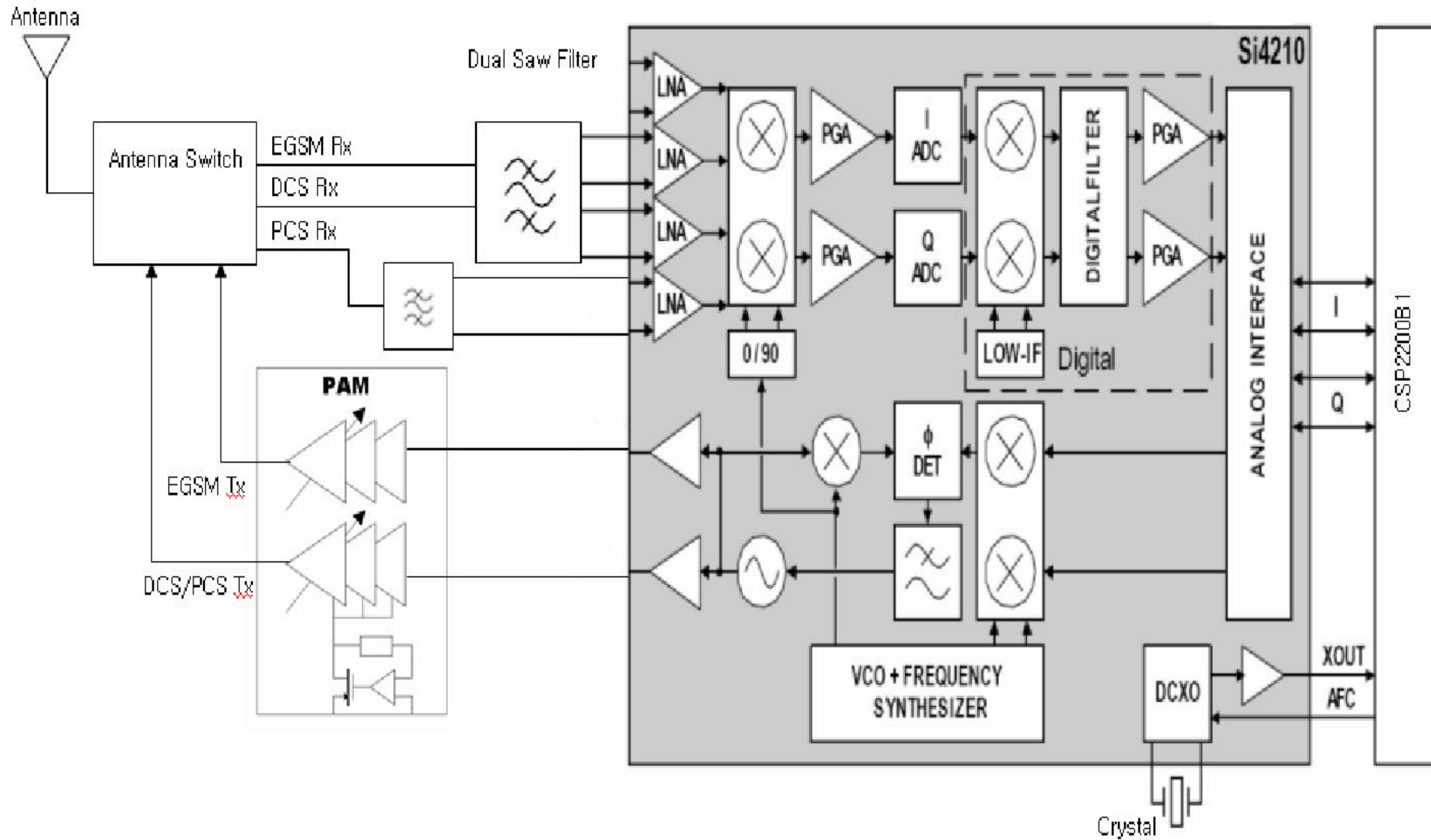

5-2. Base Band Solution Block Diagram

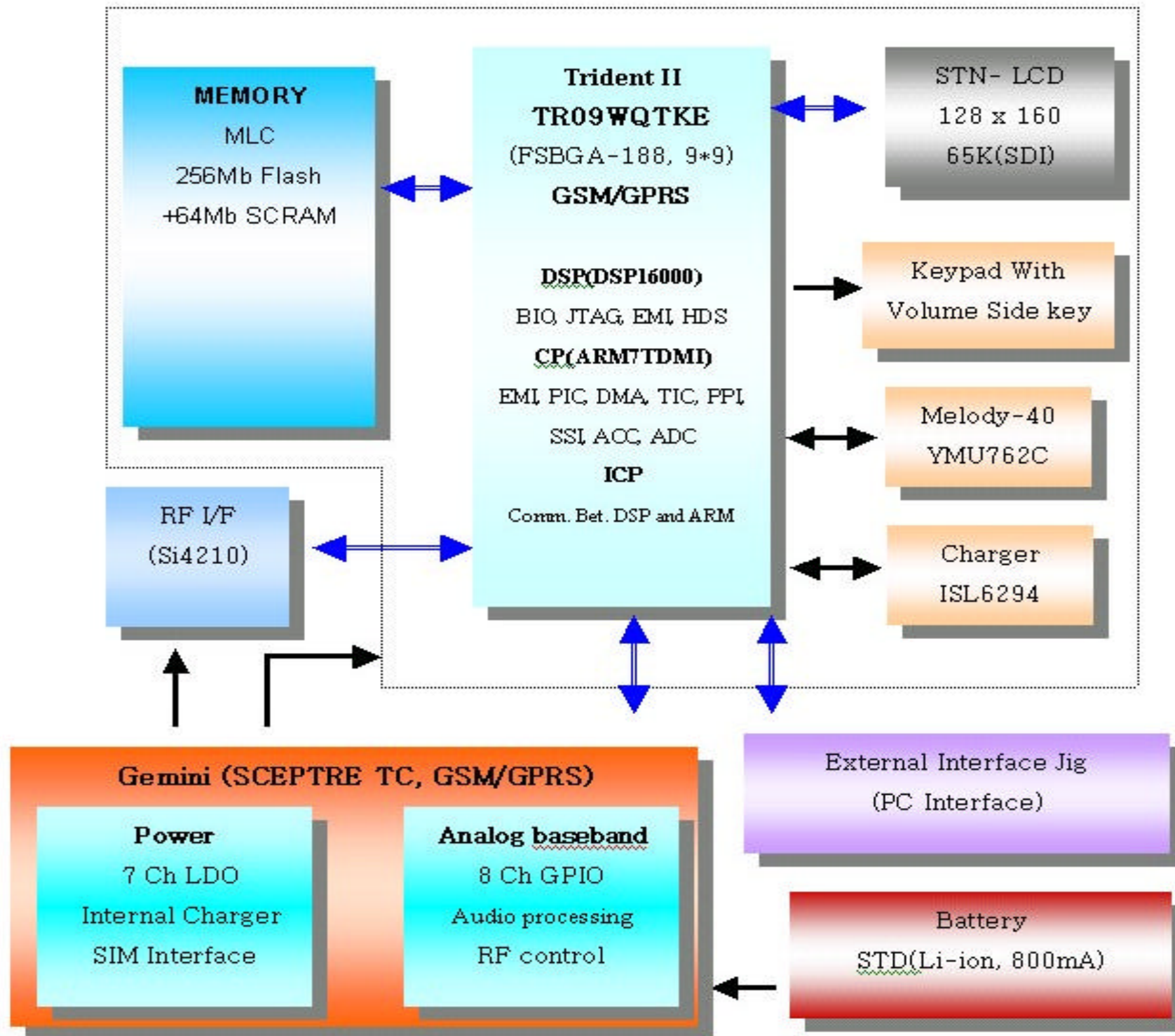



## 6. PCB Diagrams

### 6-1. PCB Top Diagram



6-2. PCB Bottom Diagram

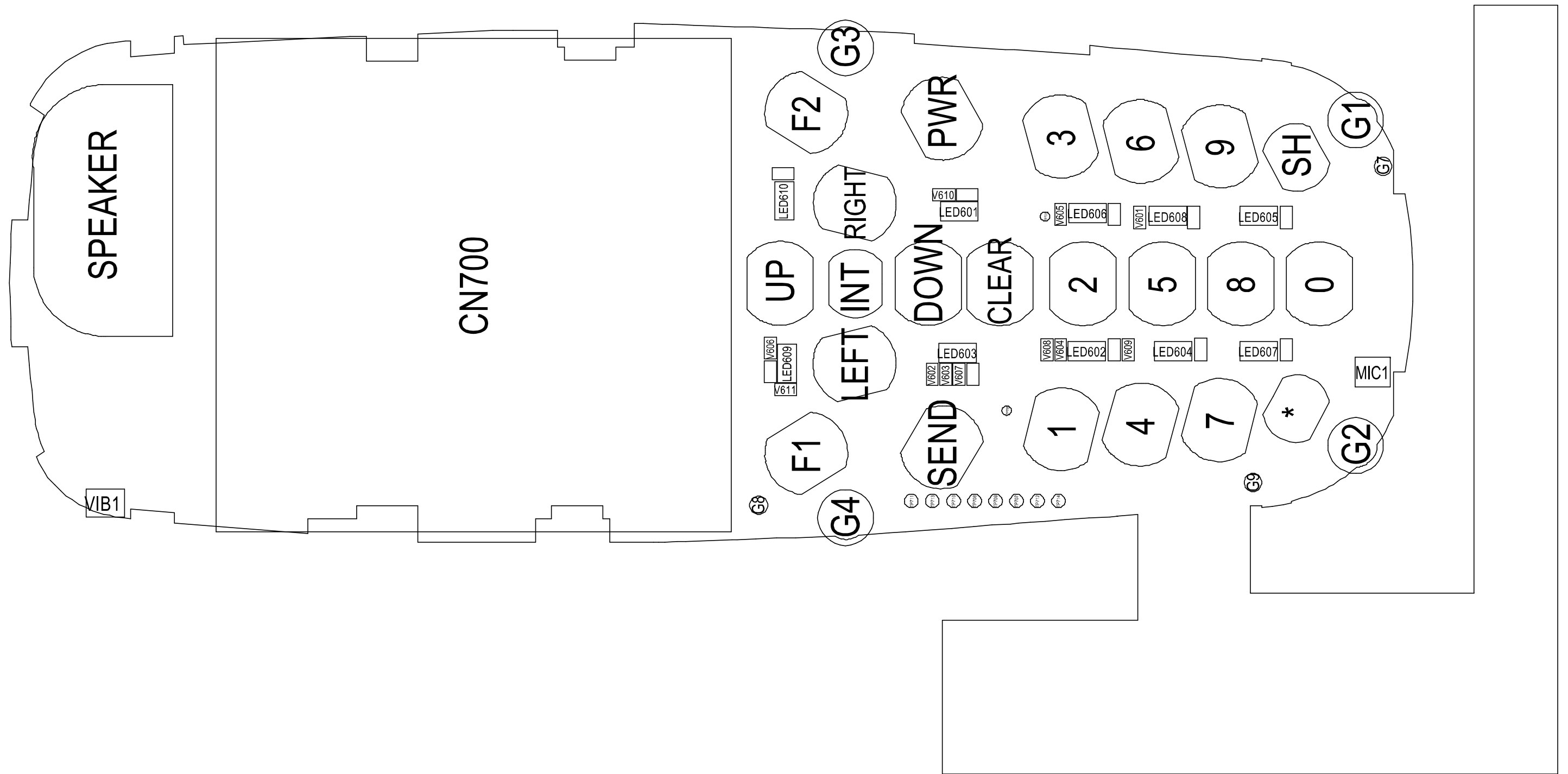

---

## 7. Flow Chart of Troubleshooting

---

### 7-1. Power On

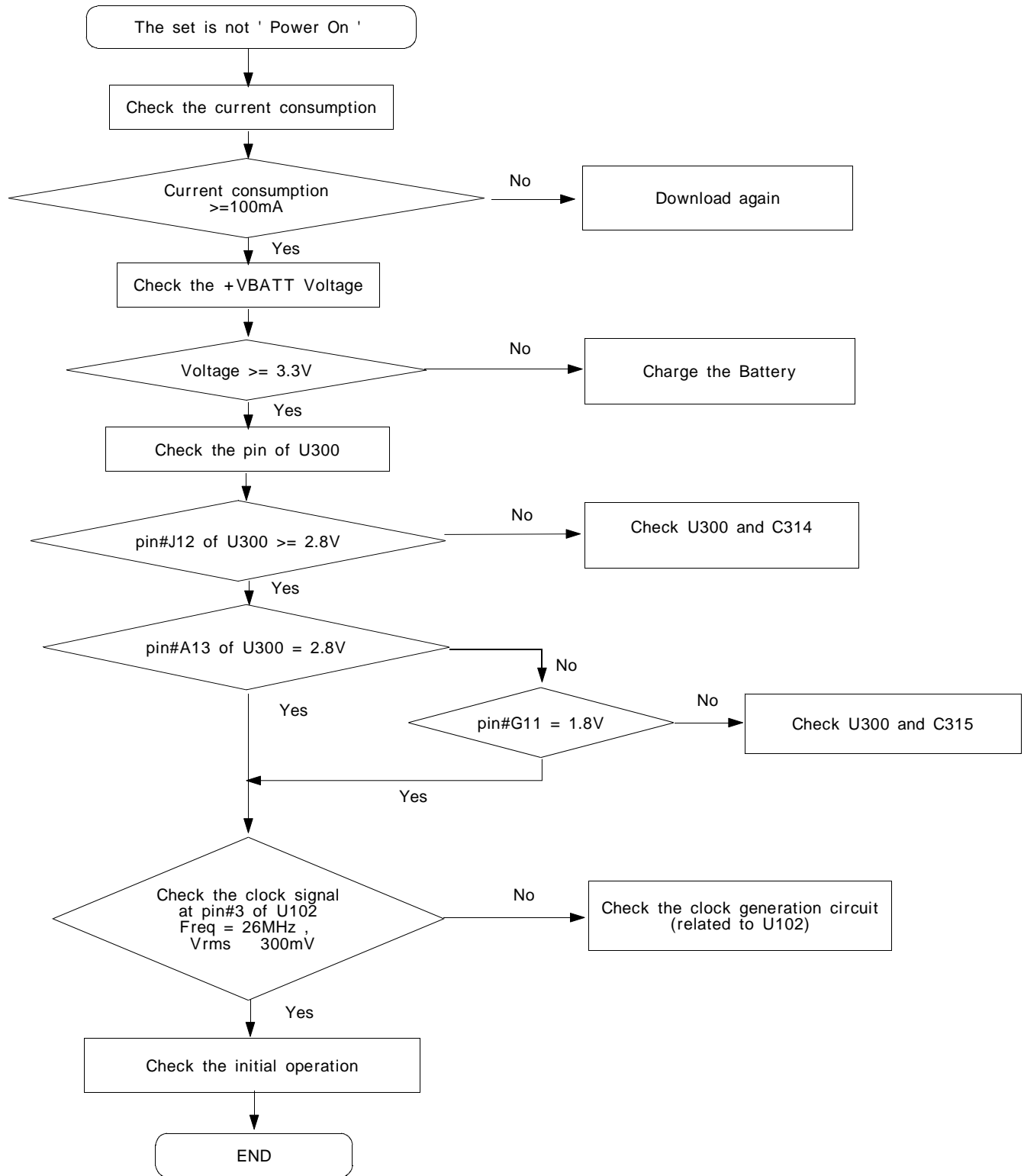

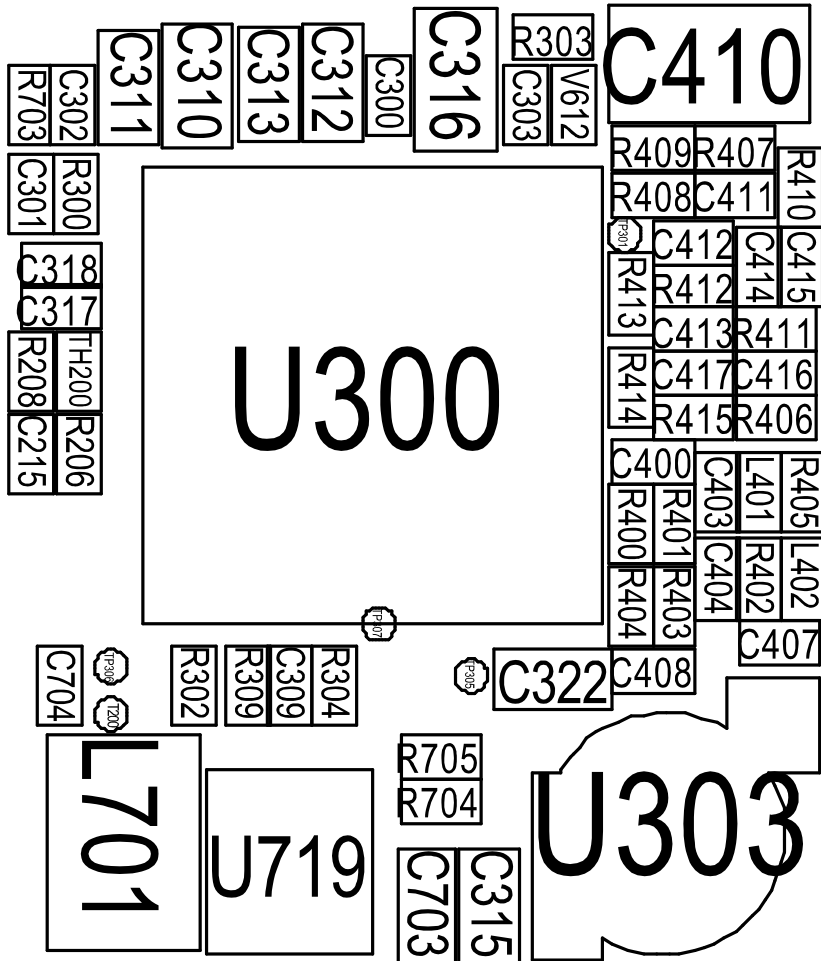

## 7-2. Initial

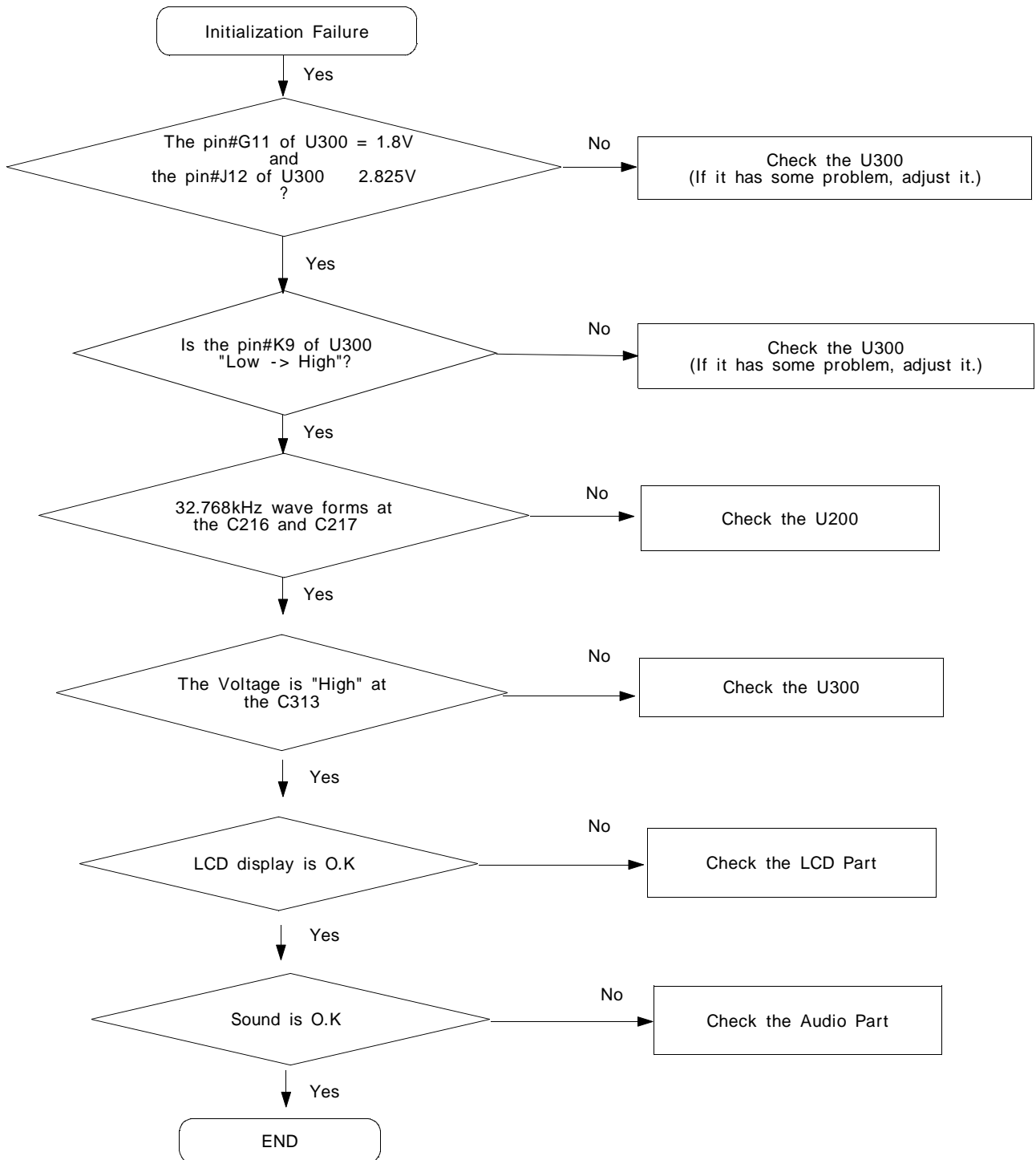

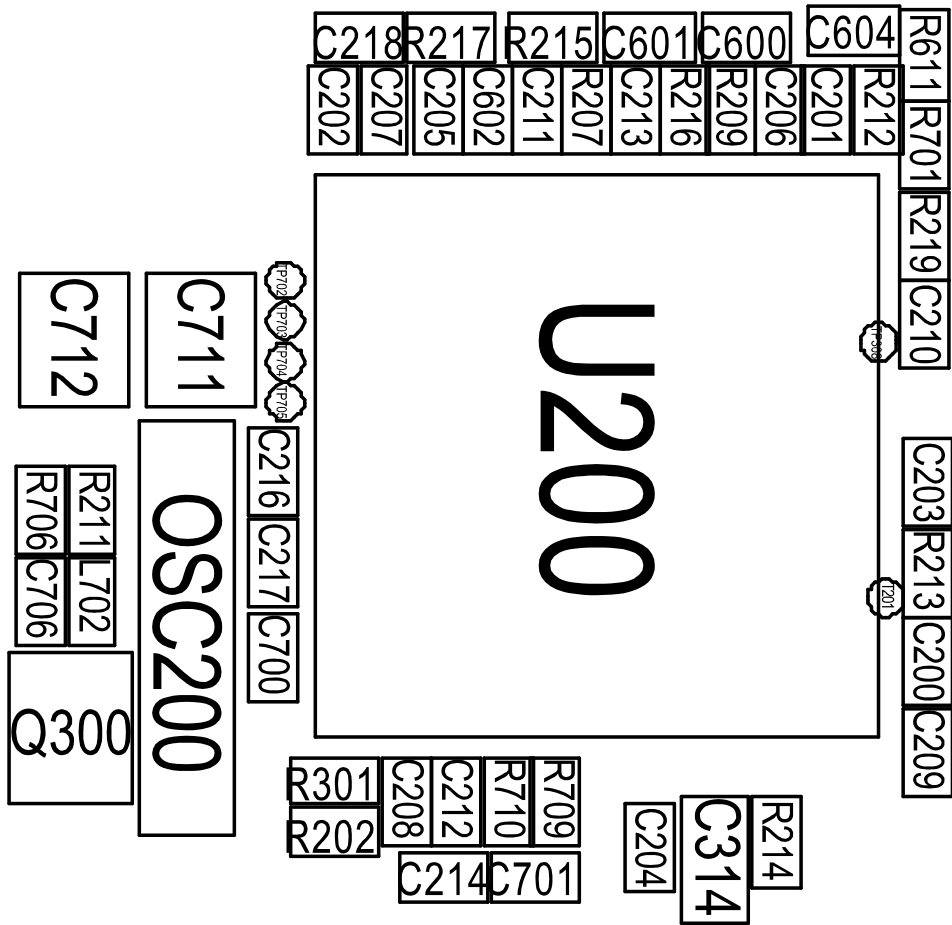

## 7-3. SIM Part

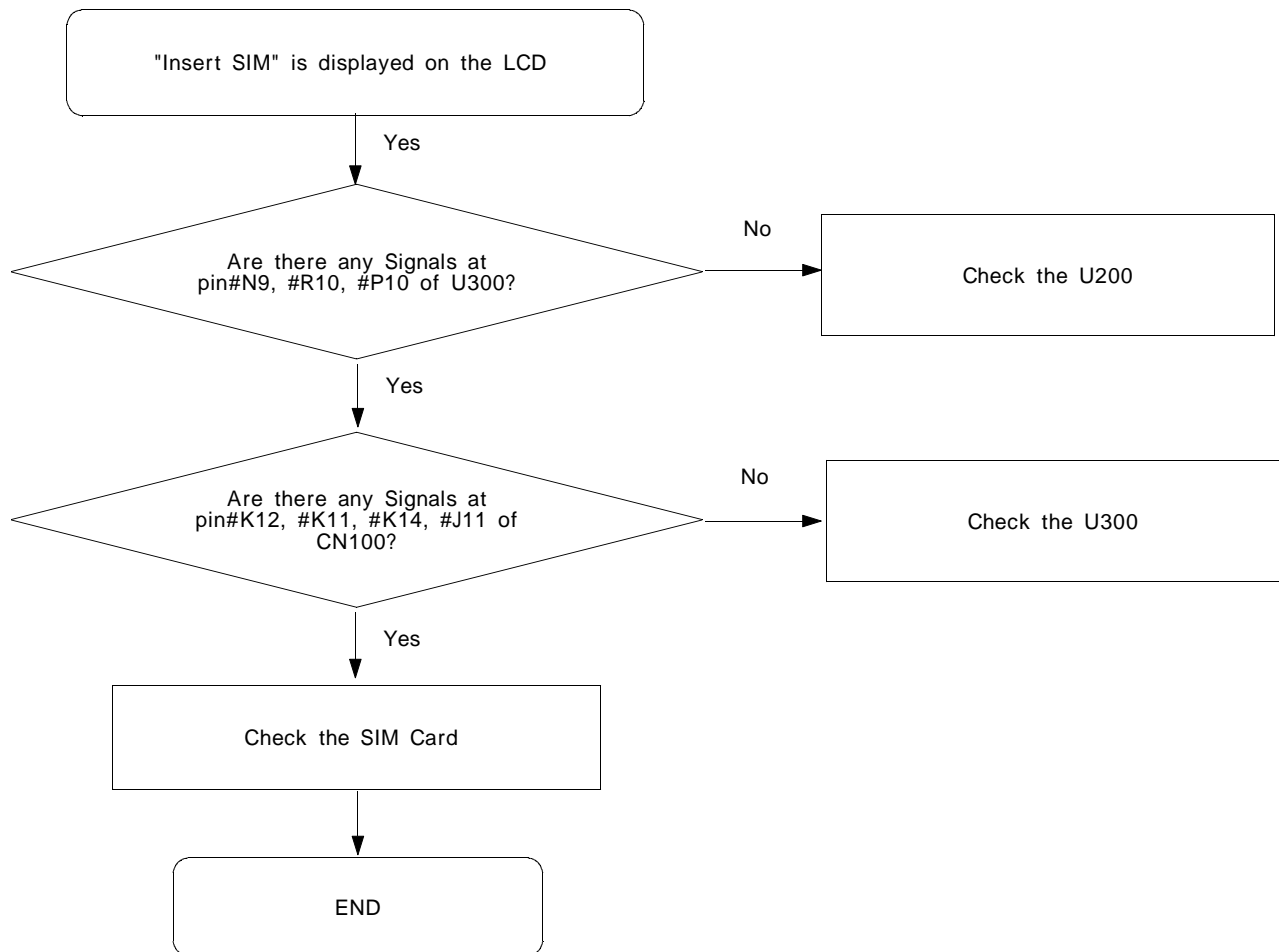

### 7-4. Charging Part

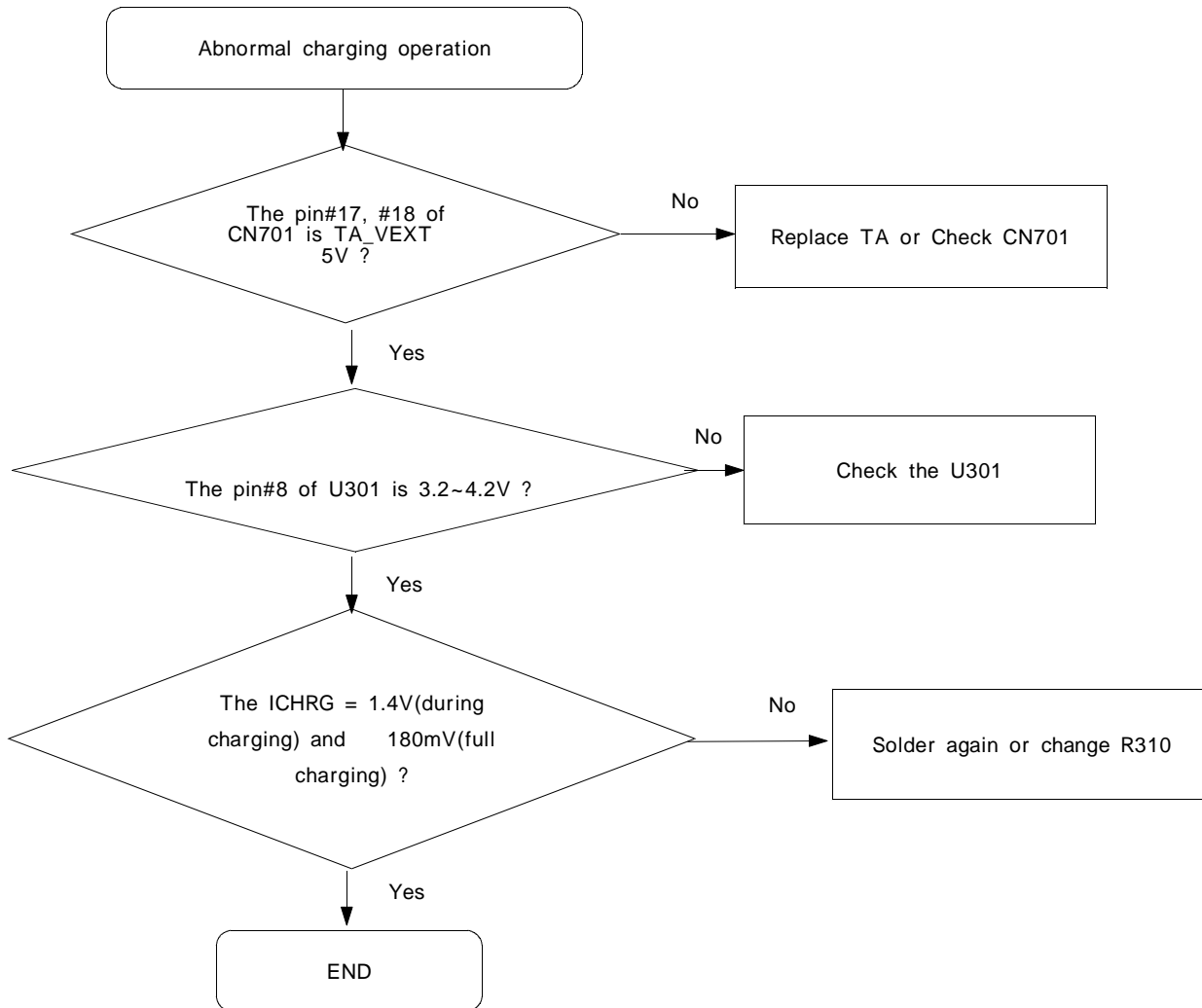



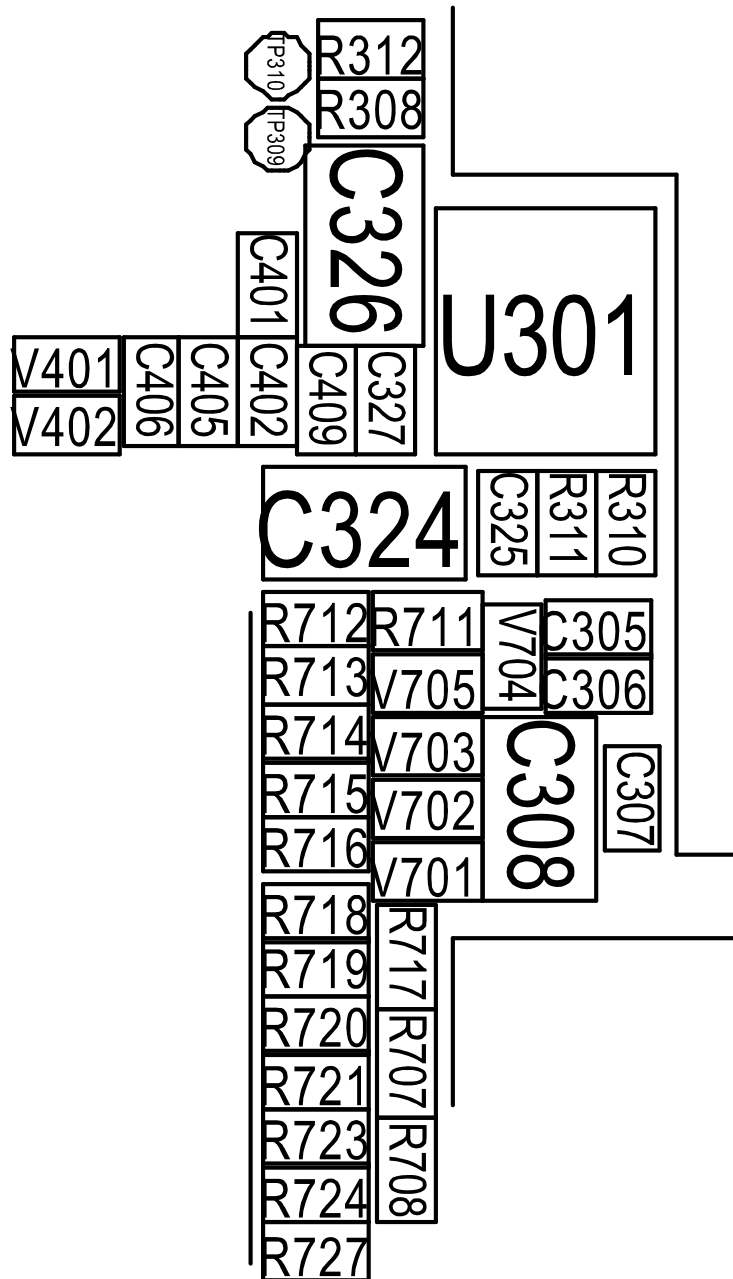

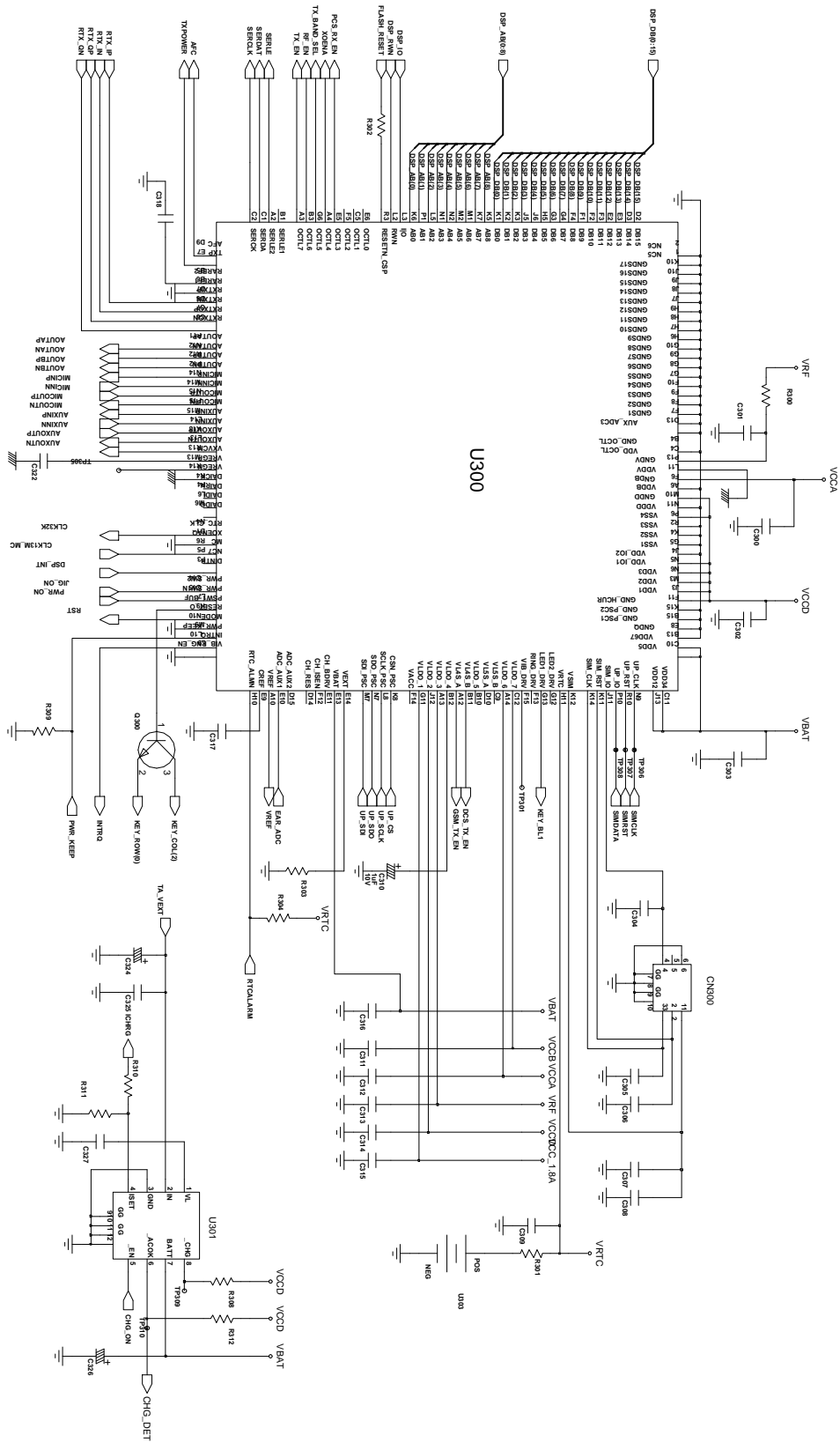

## 7-5. Microphone Part

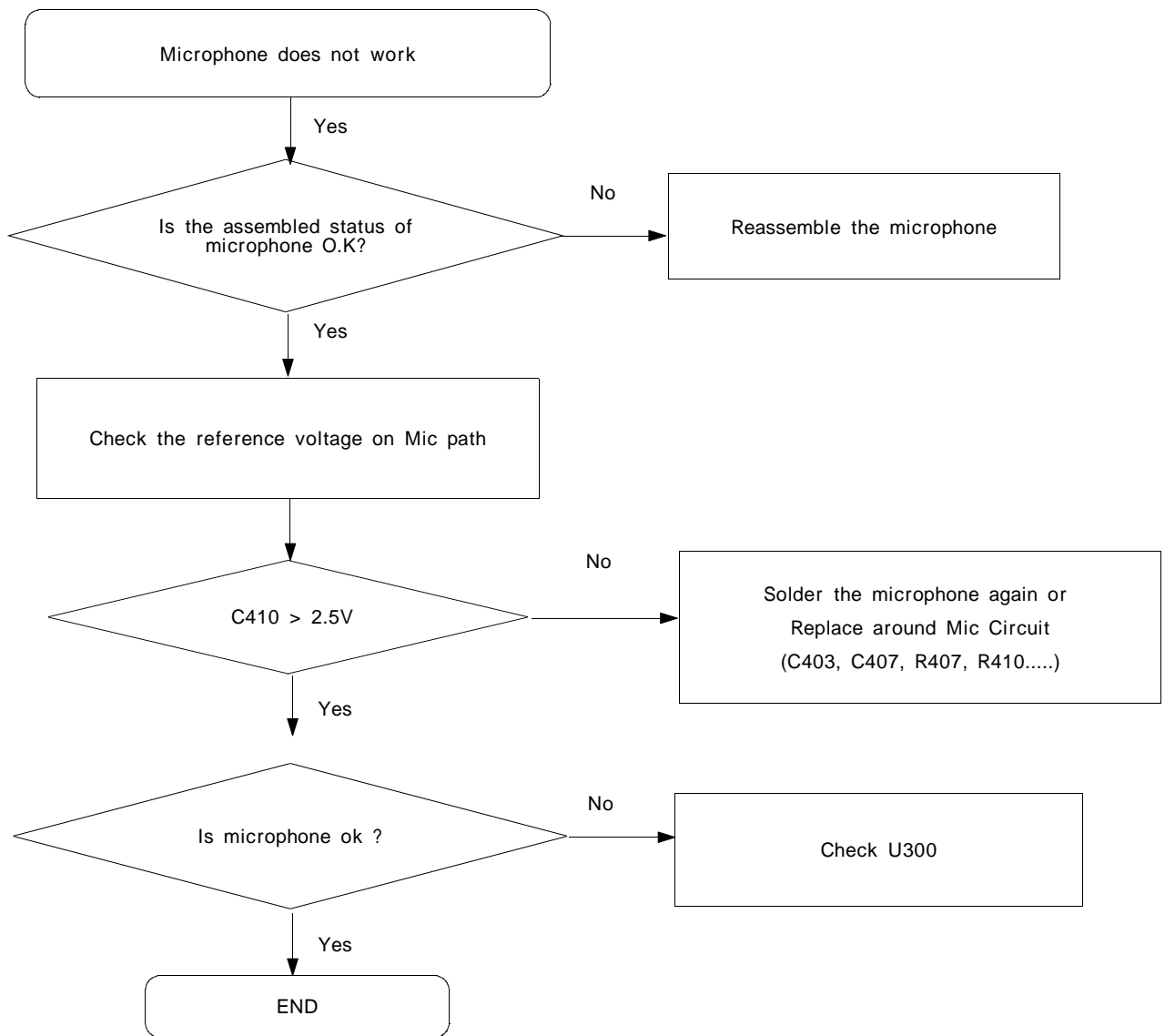

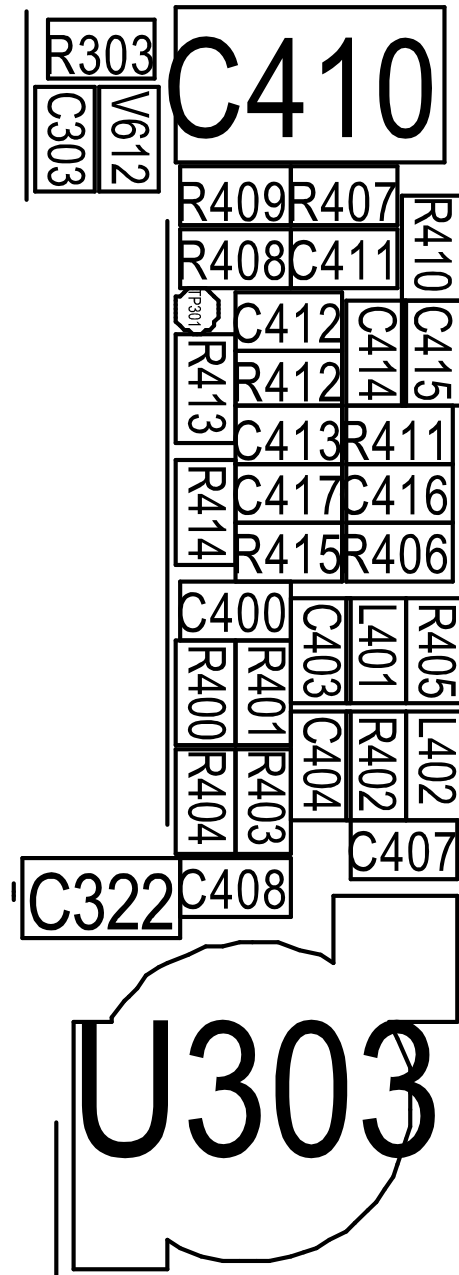

## 7-6. Speaker Part

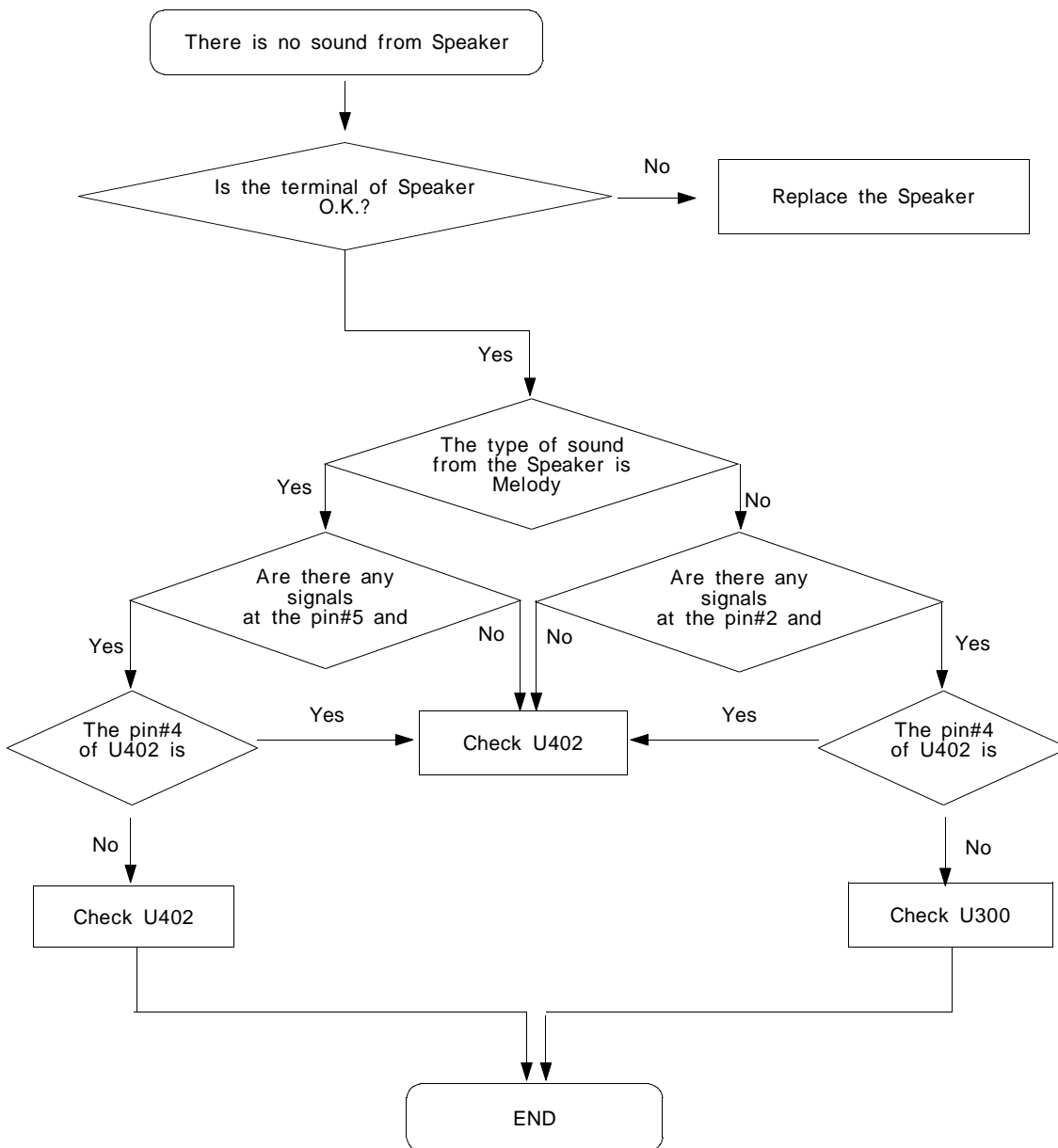

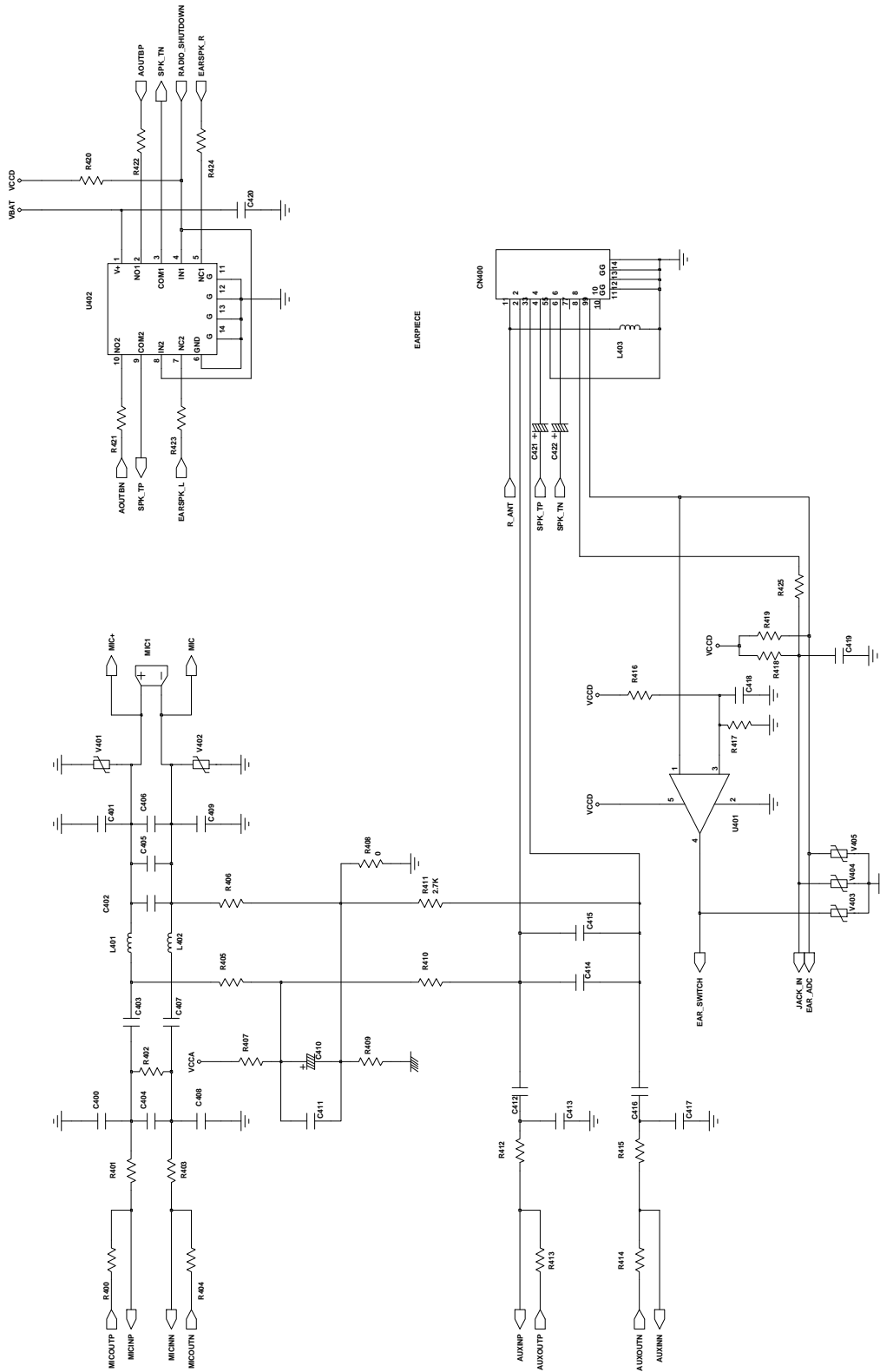

### 7-8. EGSM Reciever

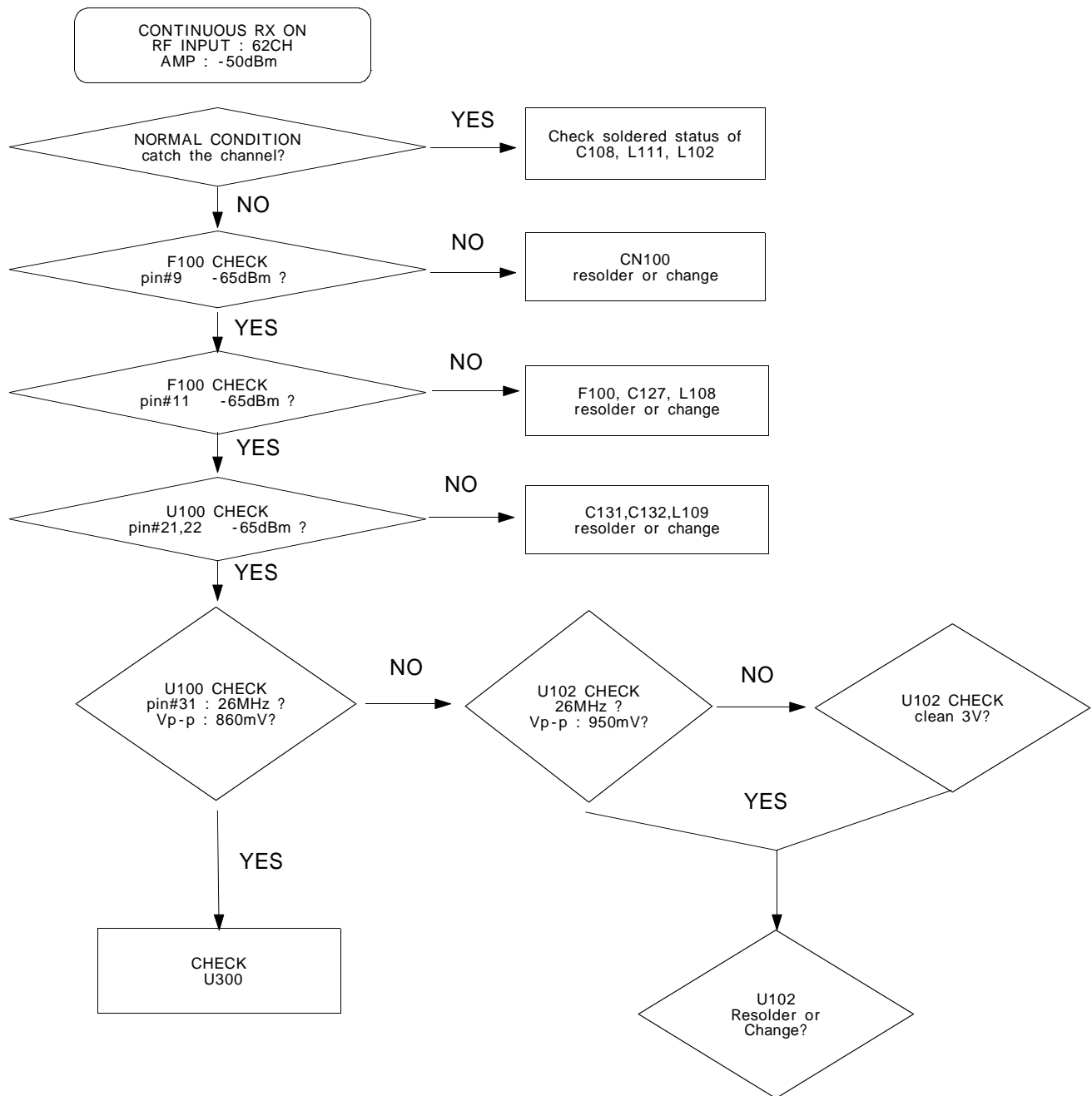

### 7-9. EGSM transmitter

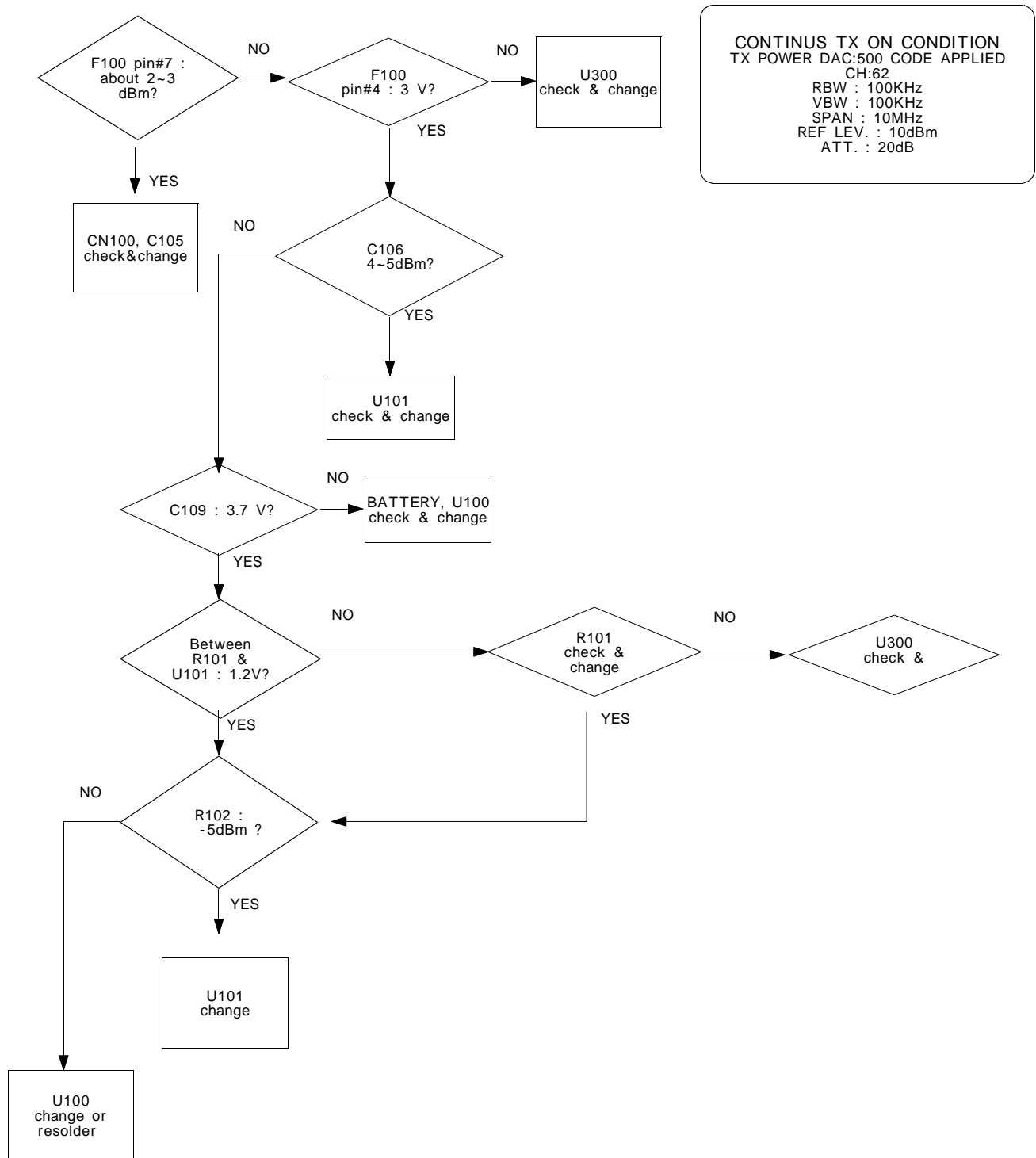



### 7-10. DCS Receiver

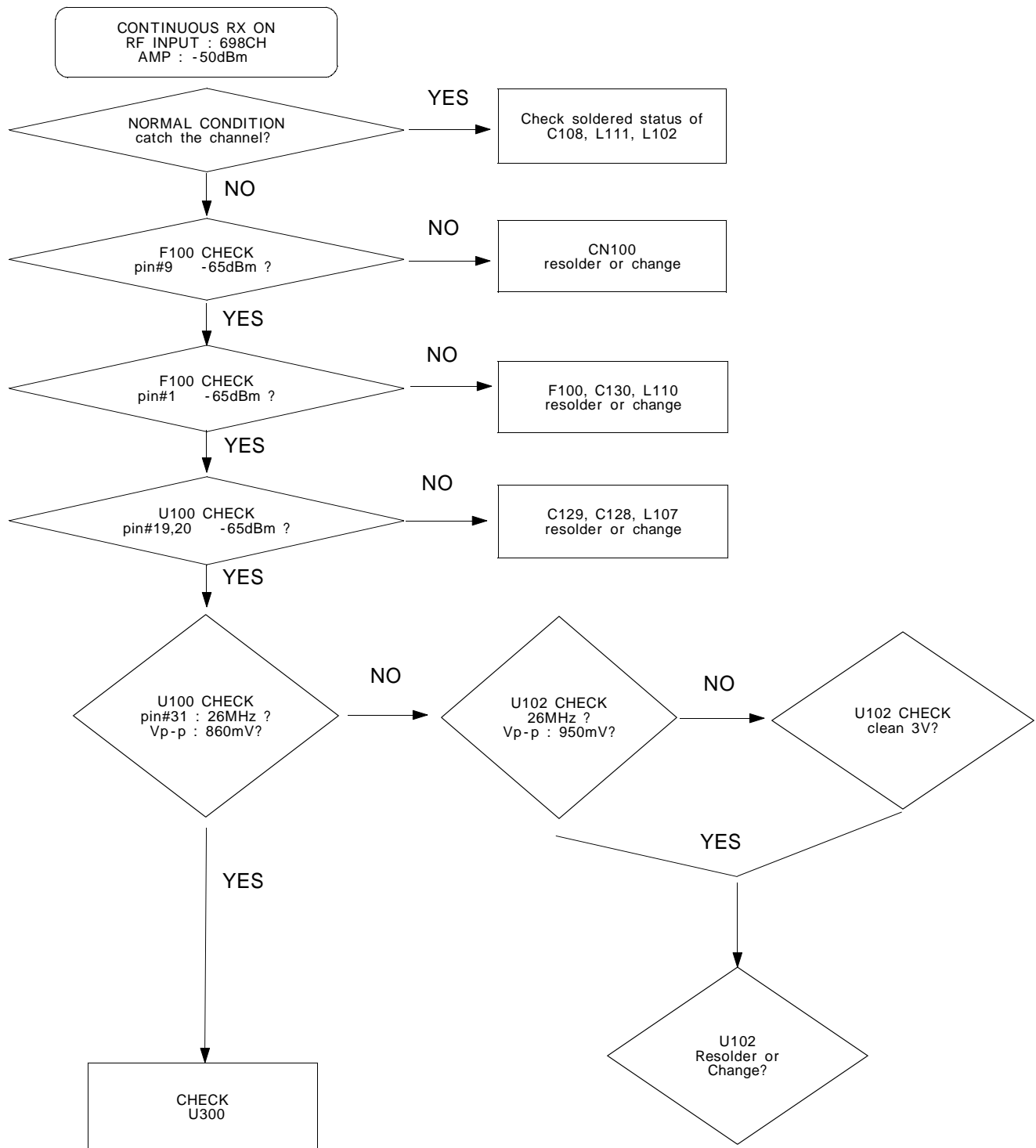

### 7-11. DCS transmitter

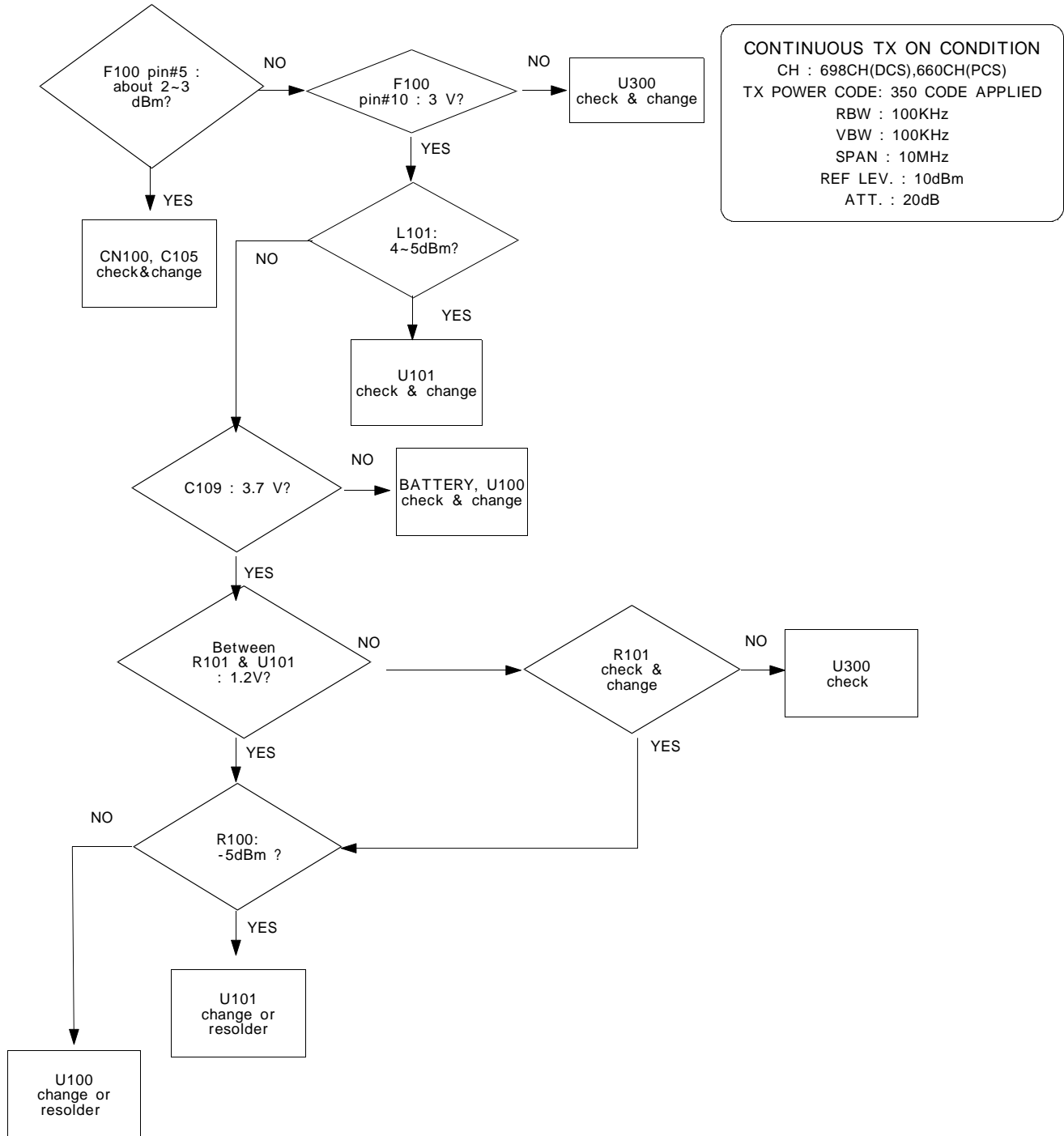

### 7-12. PCS Receiver

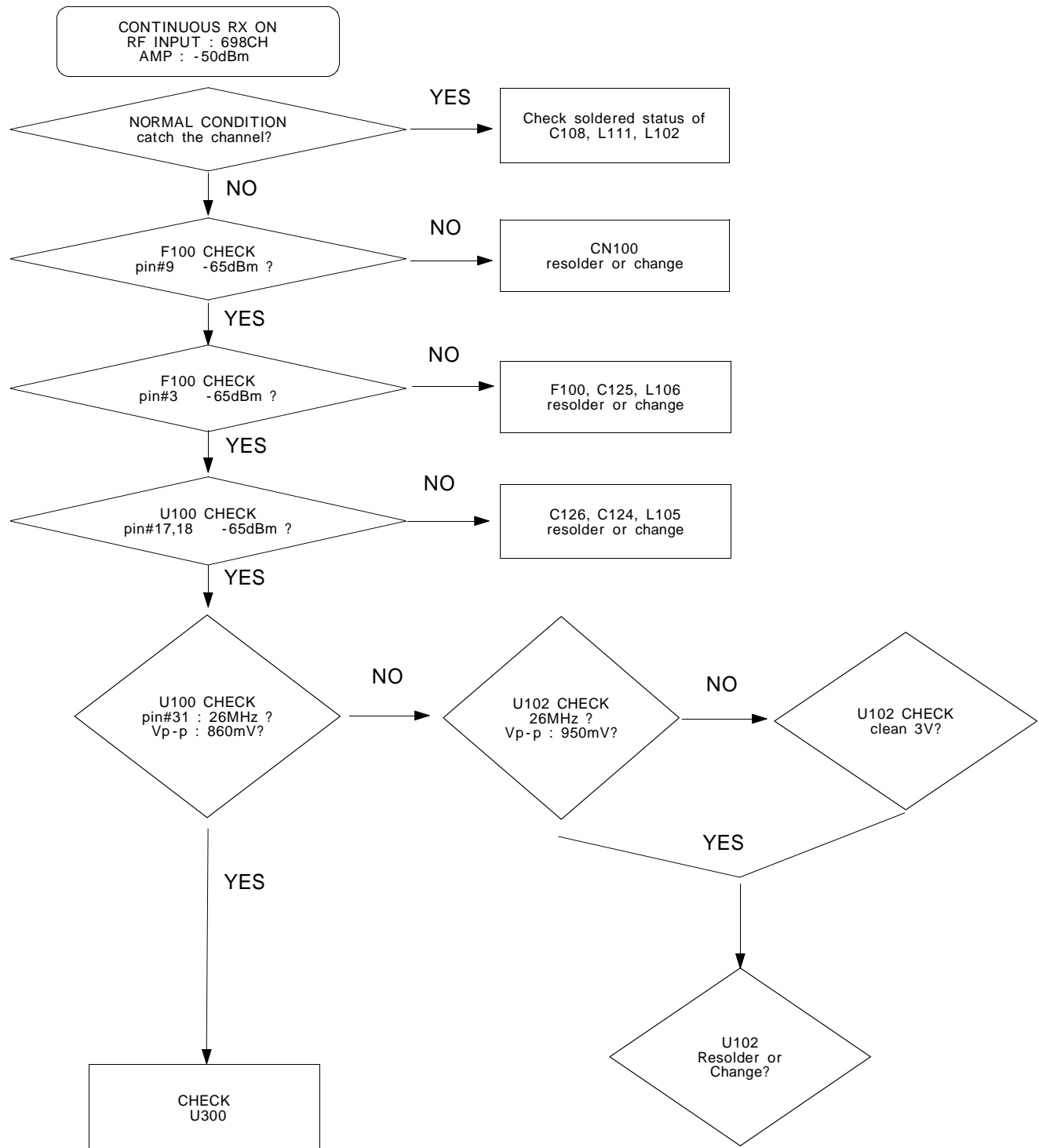

### 7-13. PCS transmitter

