

### Schematics - Main PWB

### Top Level

Version 7

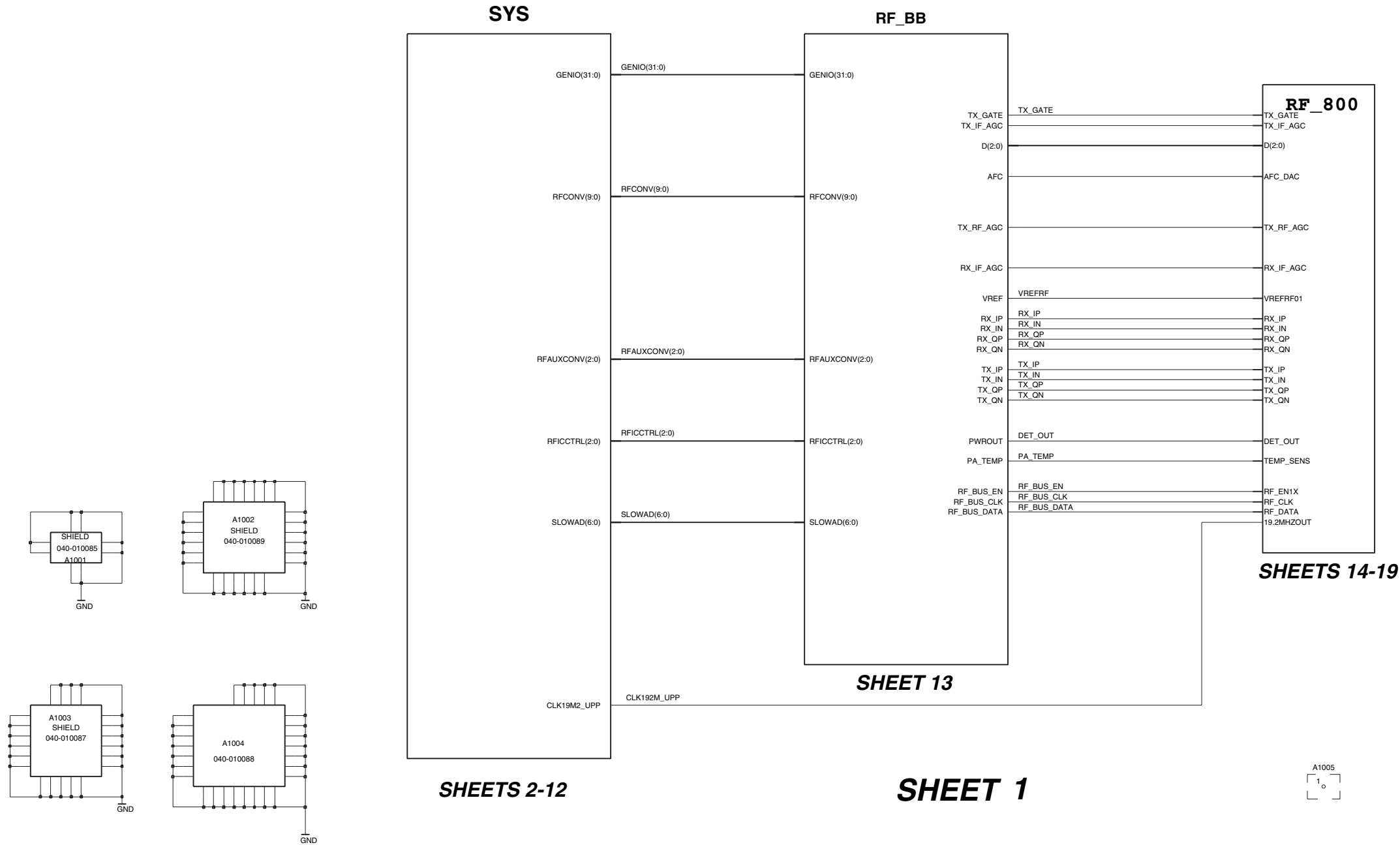

# Baseband Top Level

Version 7

## SHEET 2

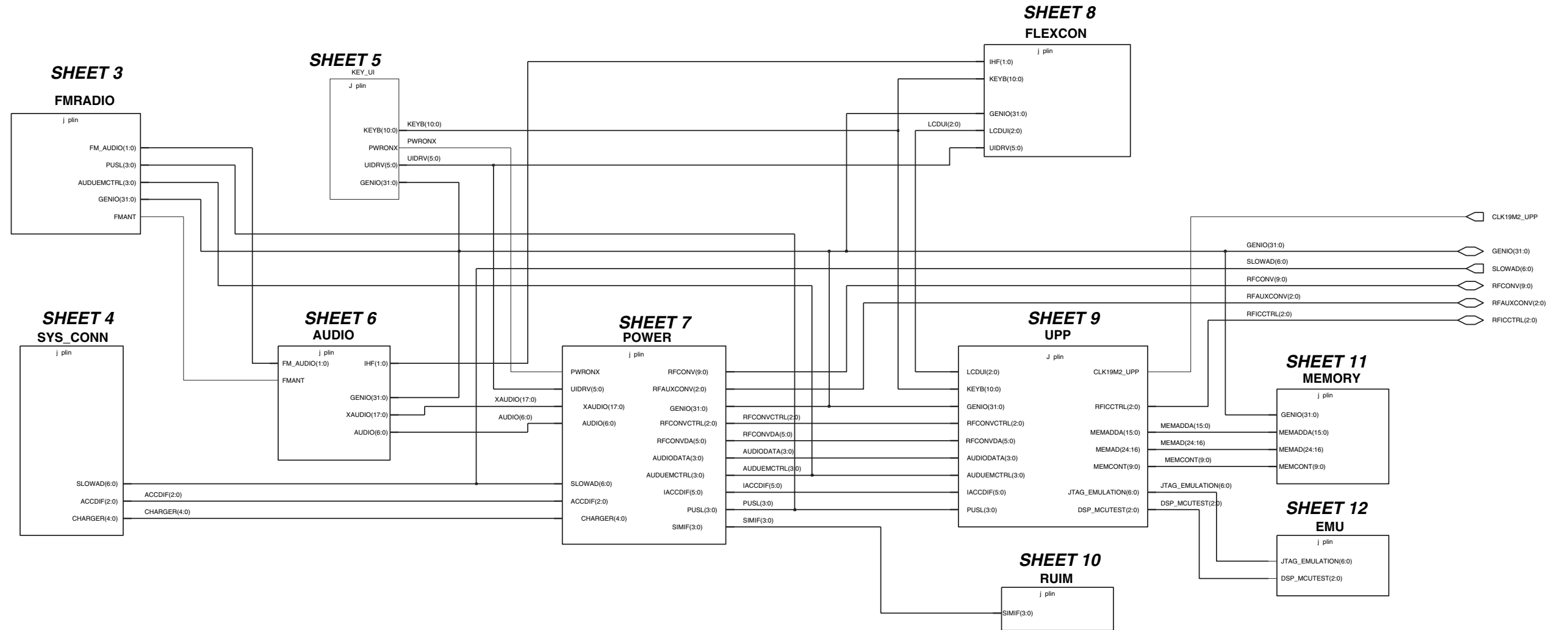

FM Radio

Version 7

SHEET 3

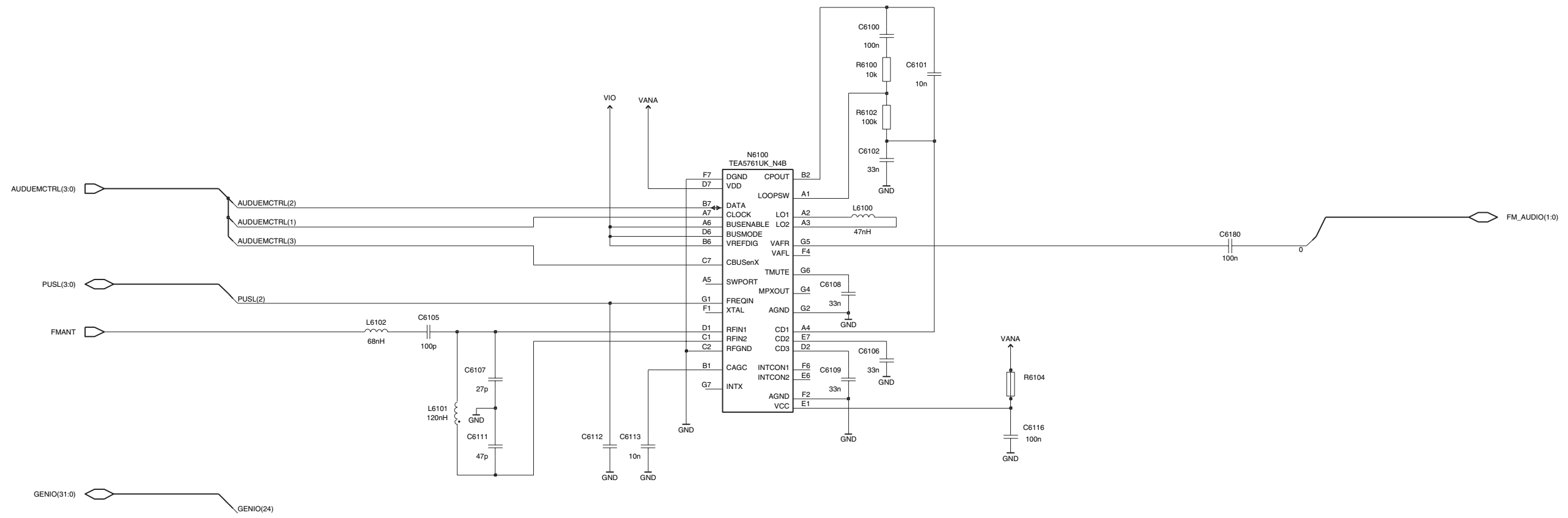

# System Connector

Version 7

## SHEET 4

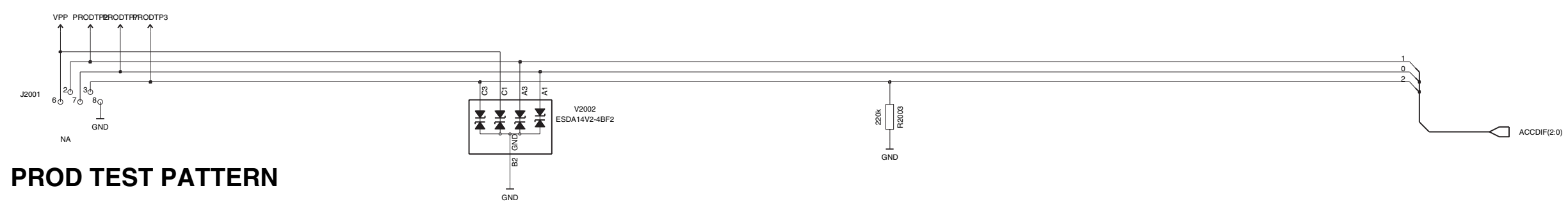
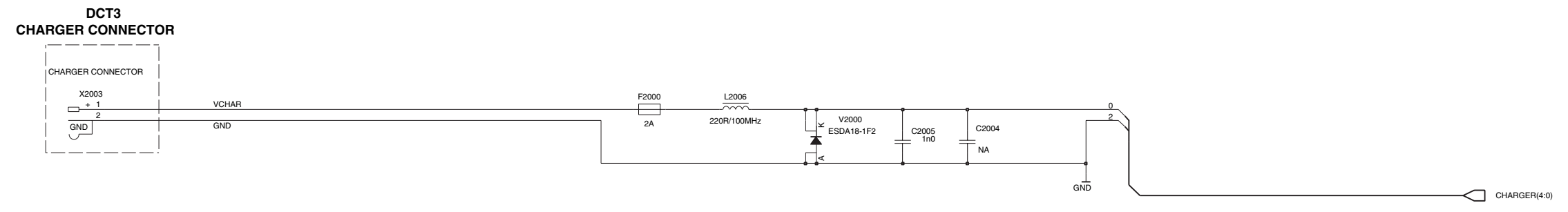
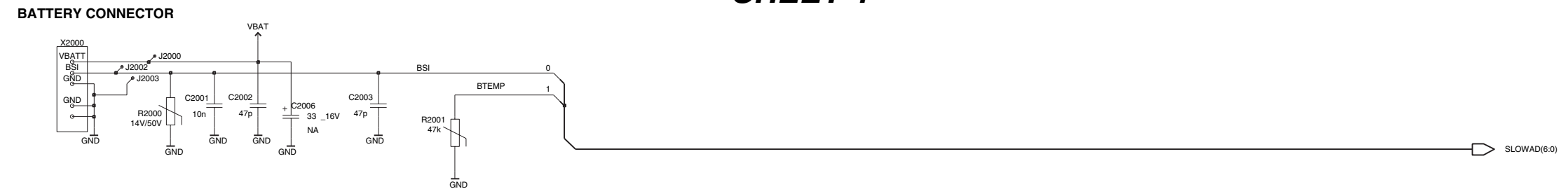

# Key UI

Version 7a

## SHEET 5

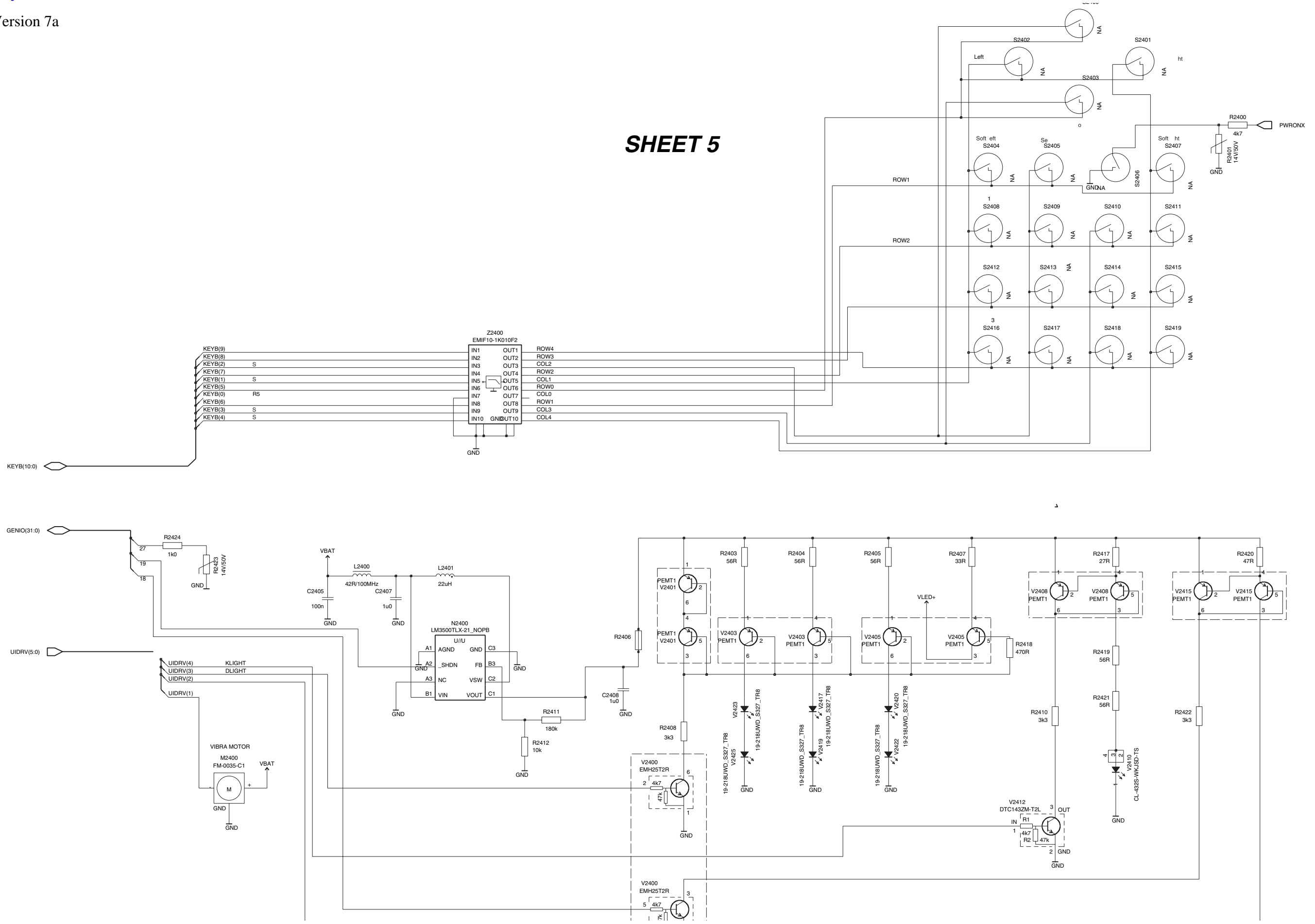

Audio

Version 7

SHEET 6

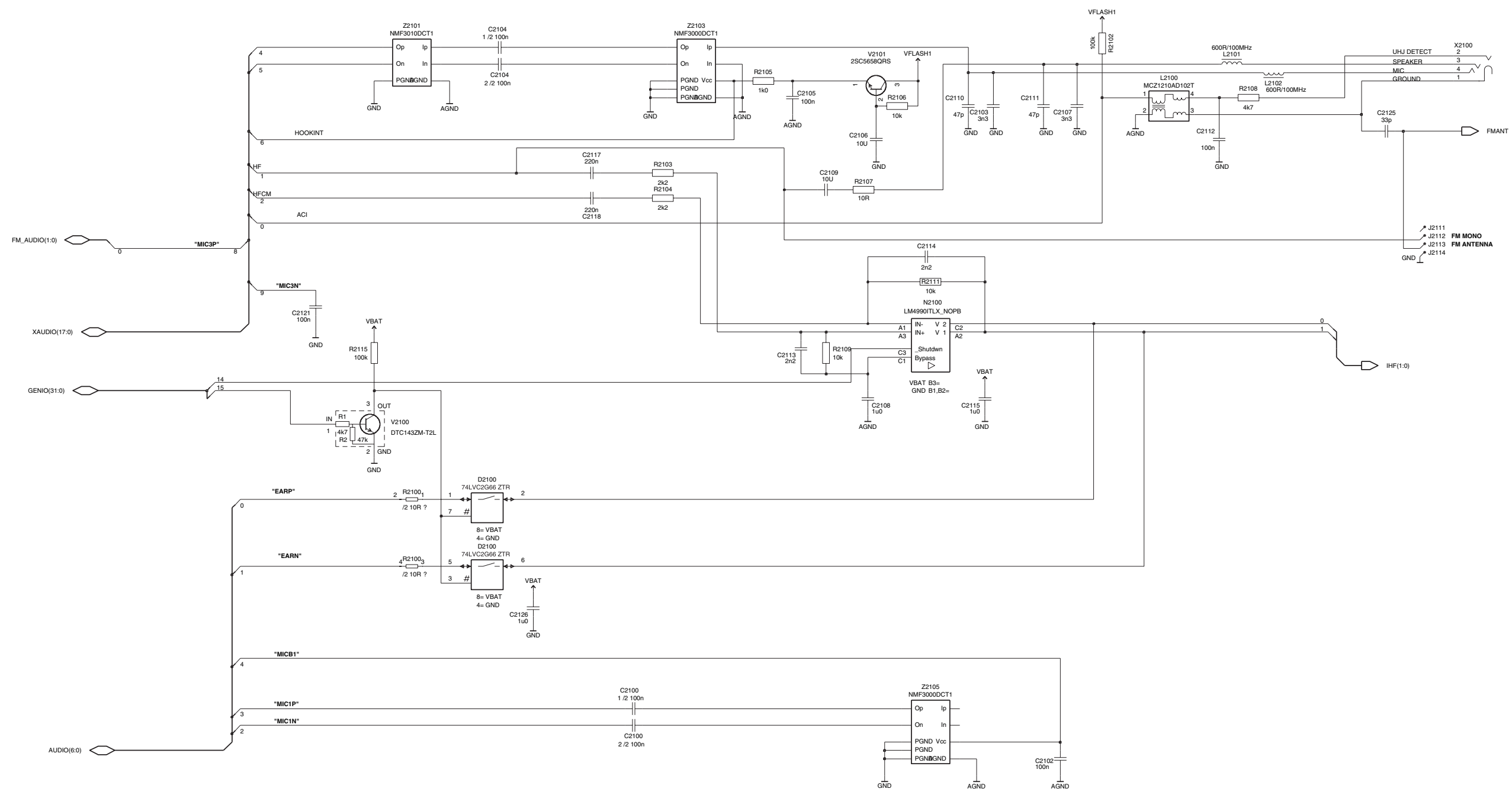

Power UEMC

Version 7

SHEET 7

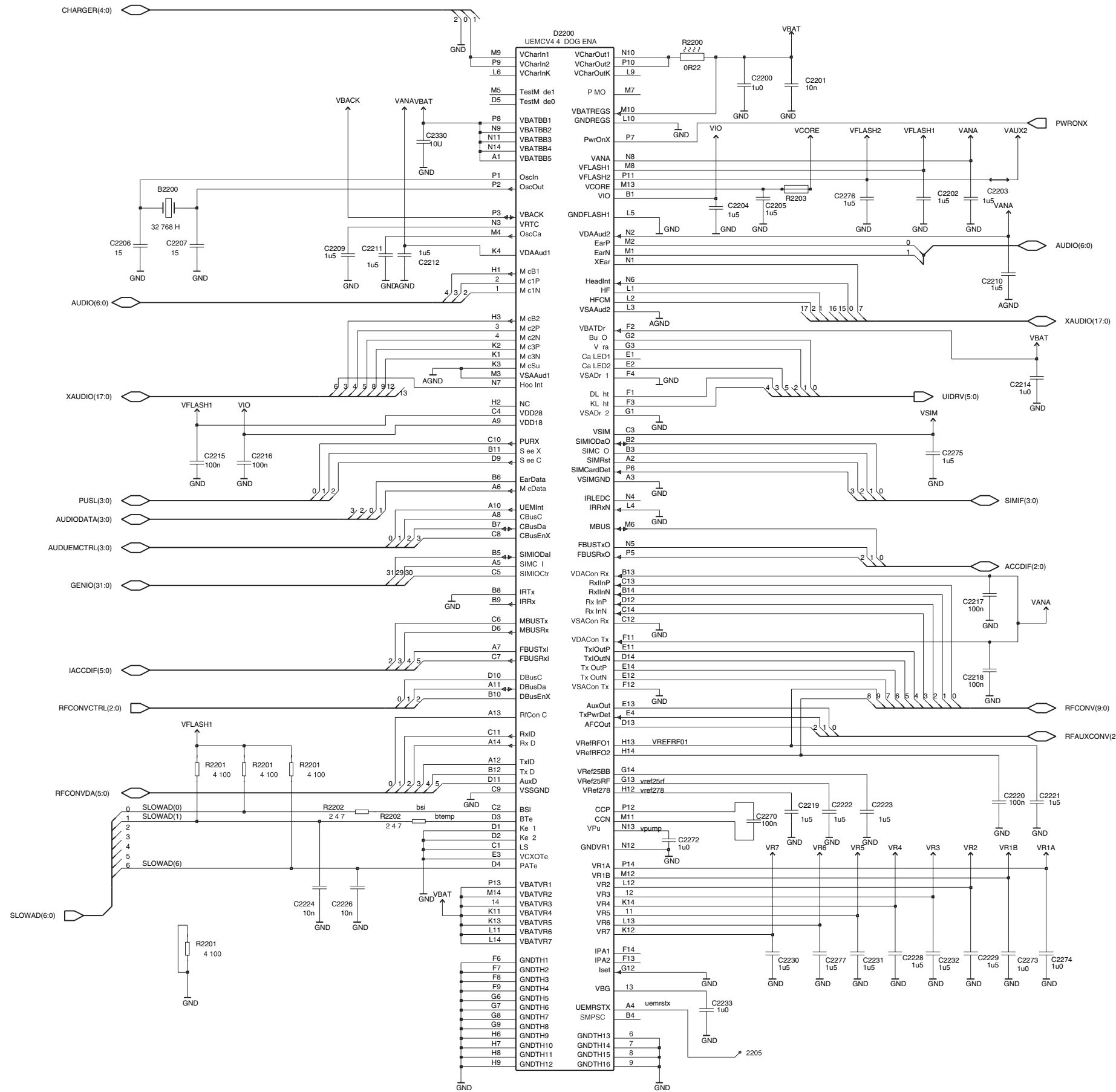

Flex Connector

Version 7

SHEET 8

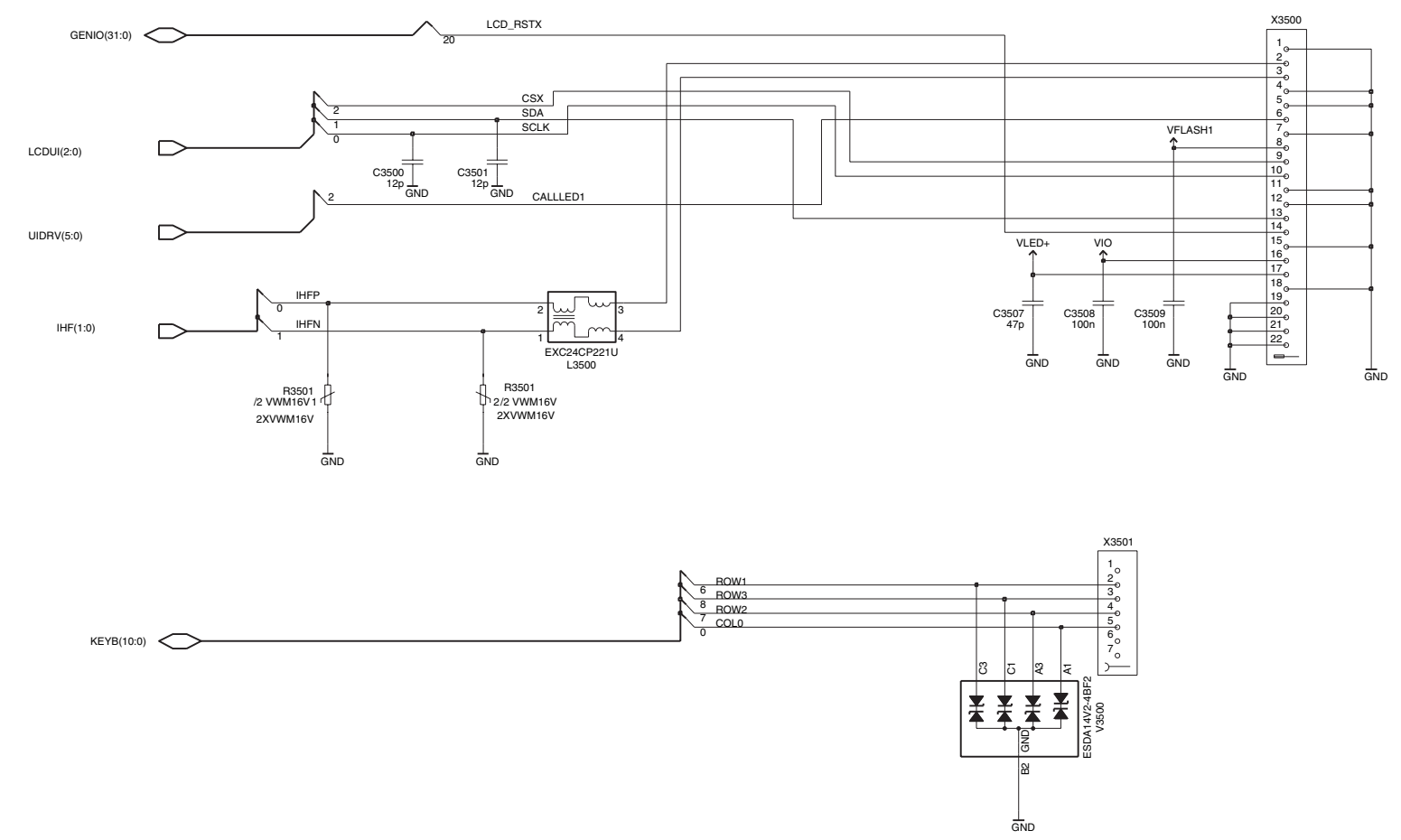



SHEET 9

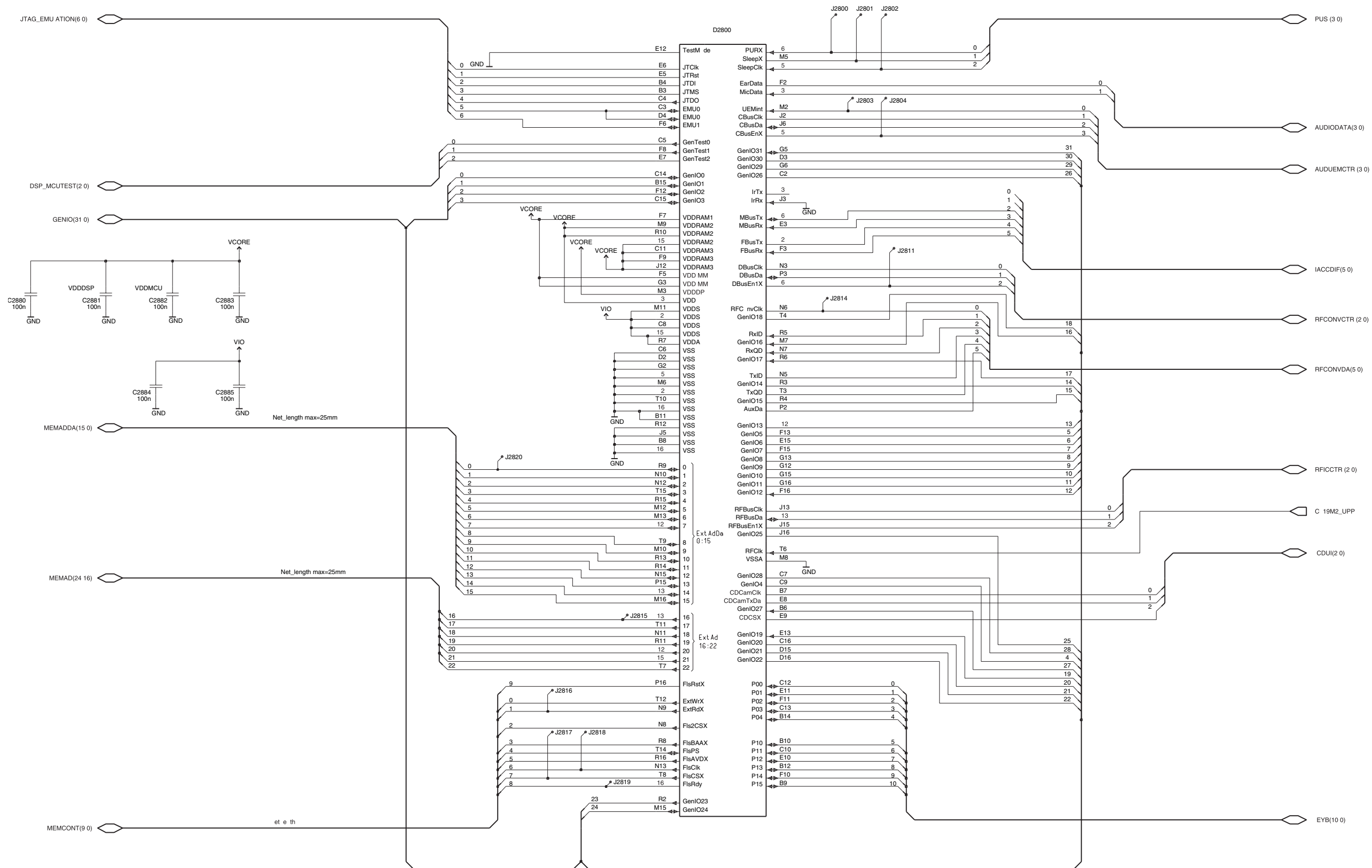

**RUM Card Connector**

Version 7

**SHEET 10**

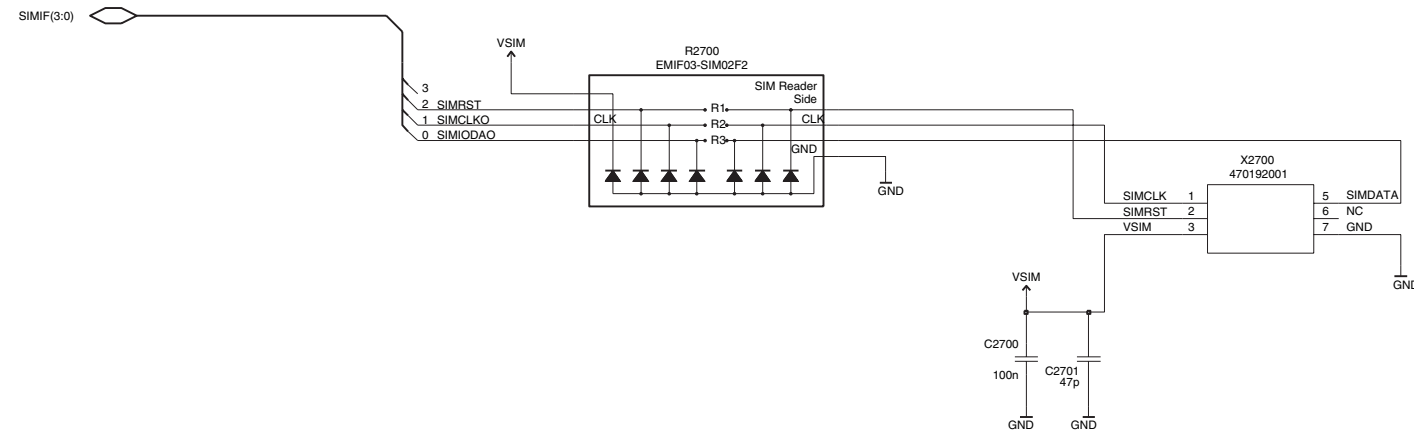

**NOT POPULATED ON NON-RUM MODULES**

# Memory

Version 7

## SHEET 11

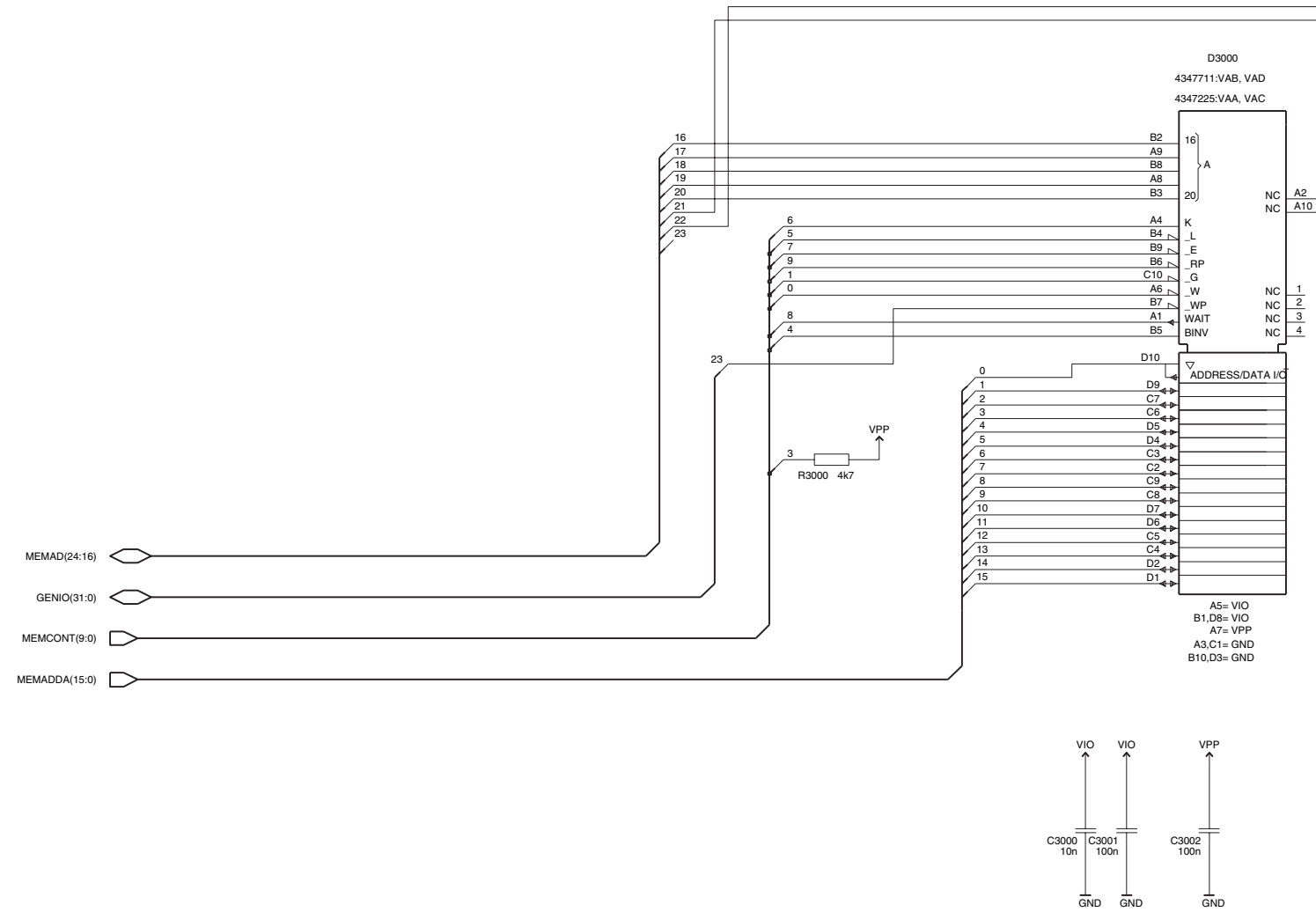

### Ostrich Connector

Version 7

#### OSTRICH

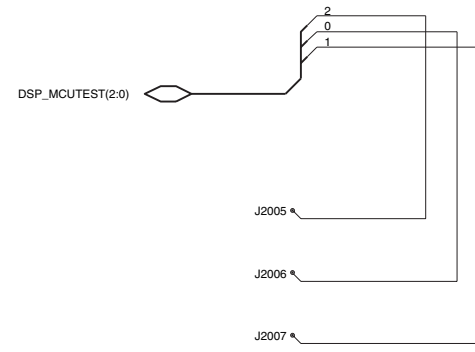

# Baseband RF Interface

Version 7

## SHEET 13

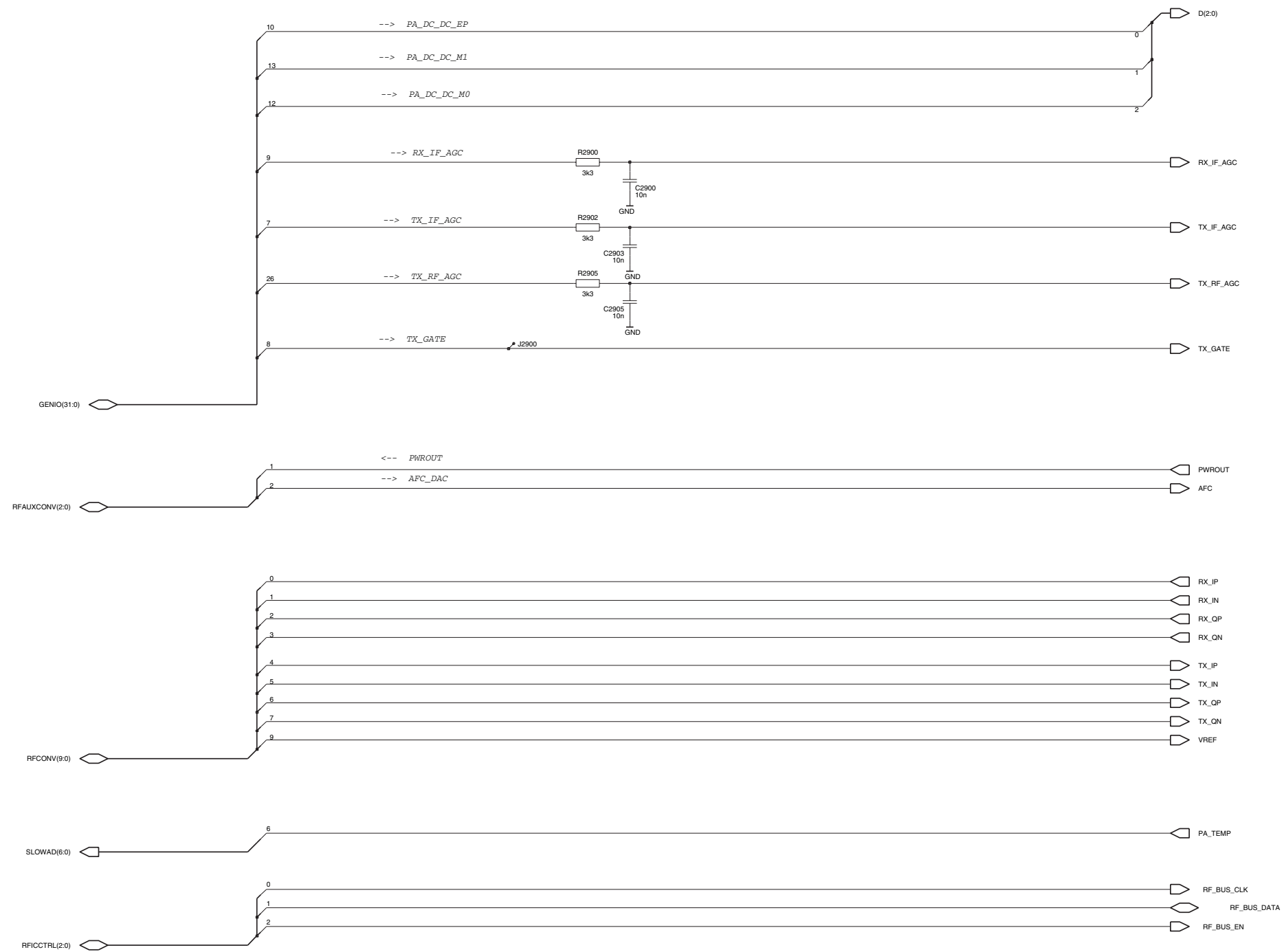

# RF Top Level

Version 7

## SHEET 14

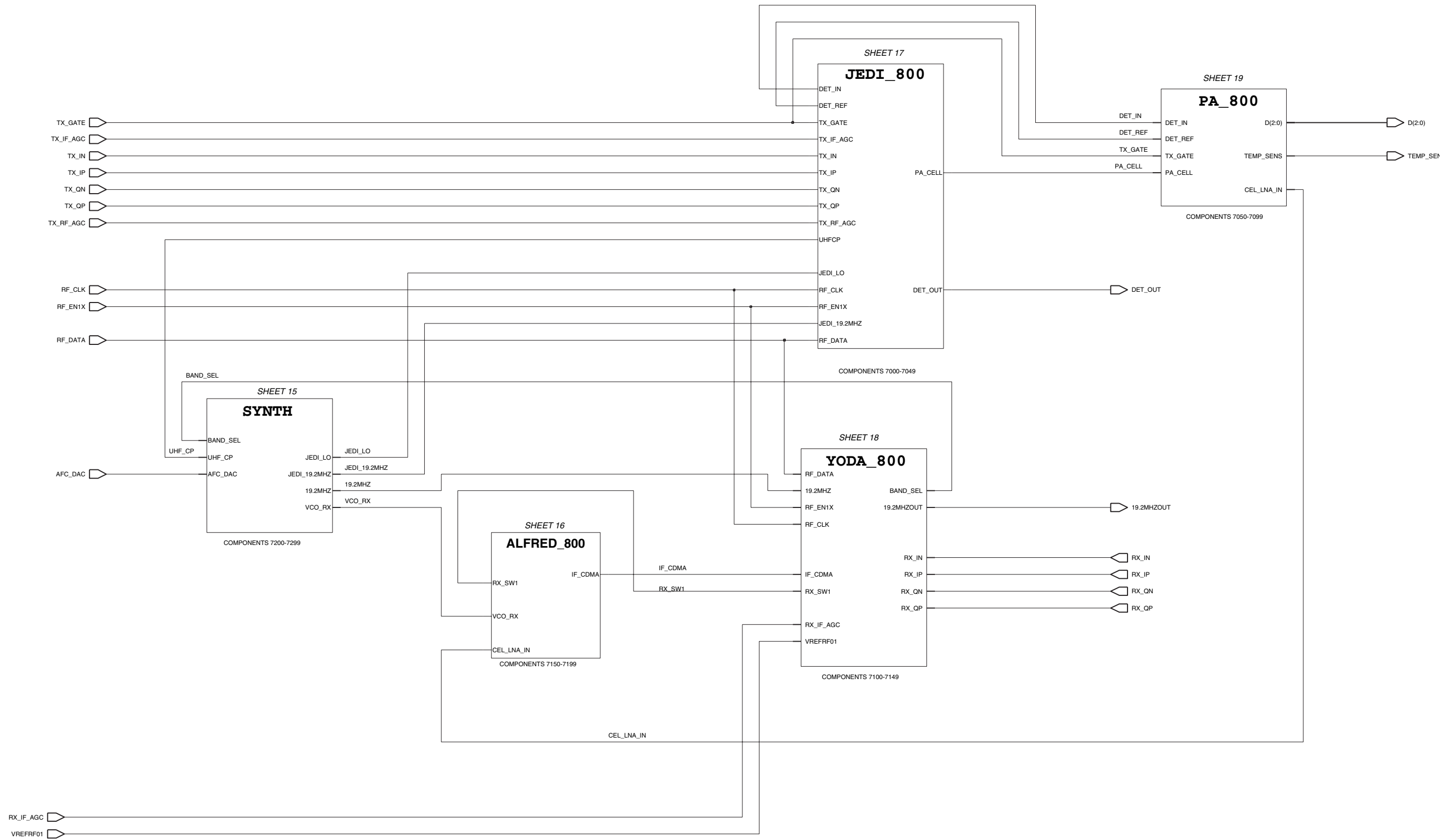

# SHEET 15

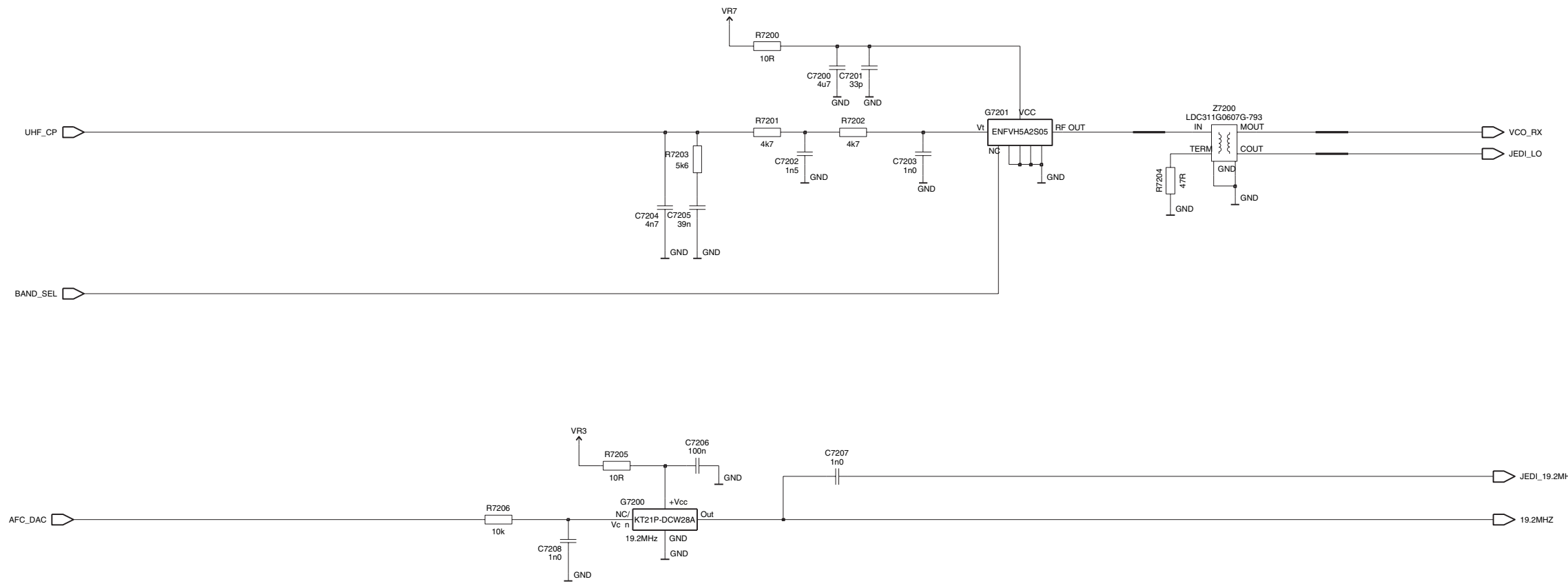

Front End – Receiver

Version 7

SHEET 16

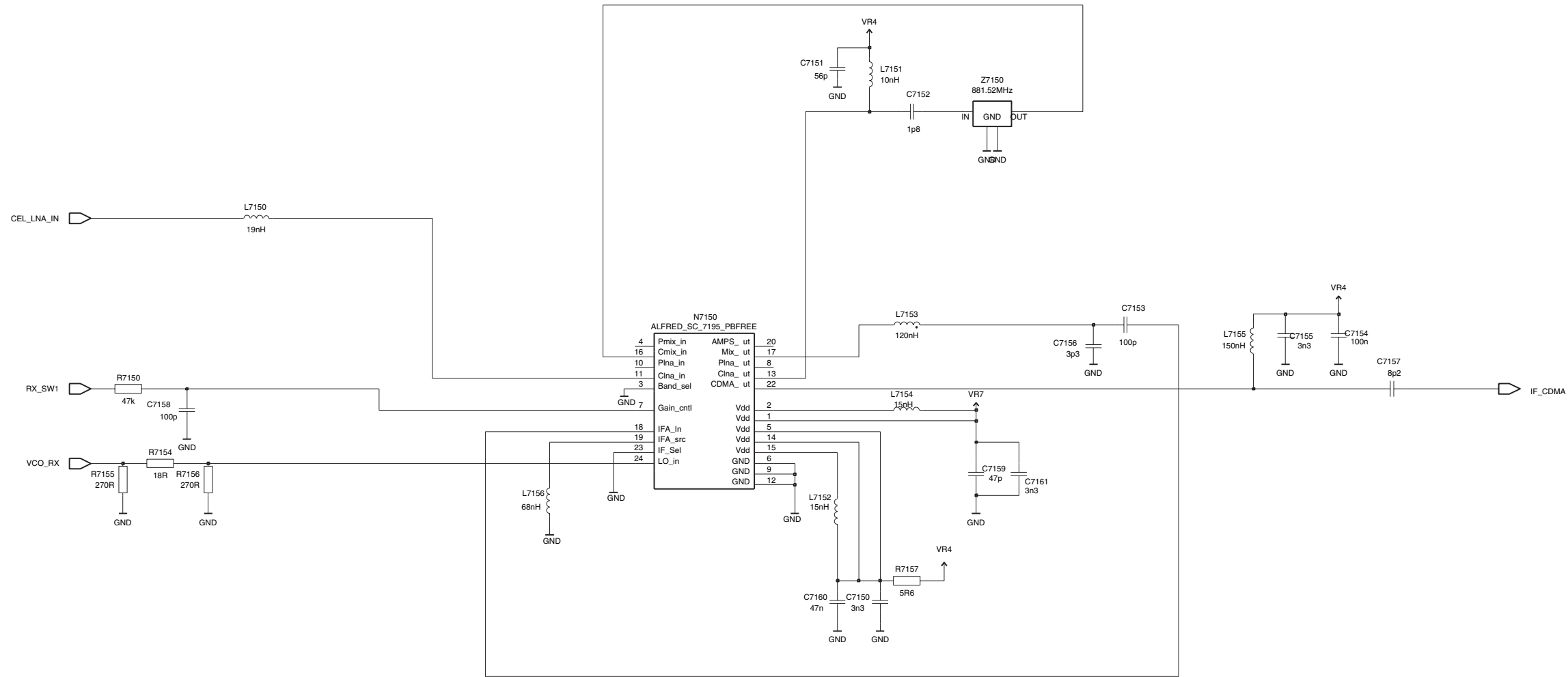



# Transmitter

Version 7

## SHEET 17

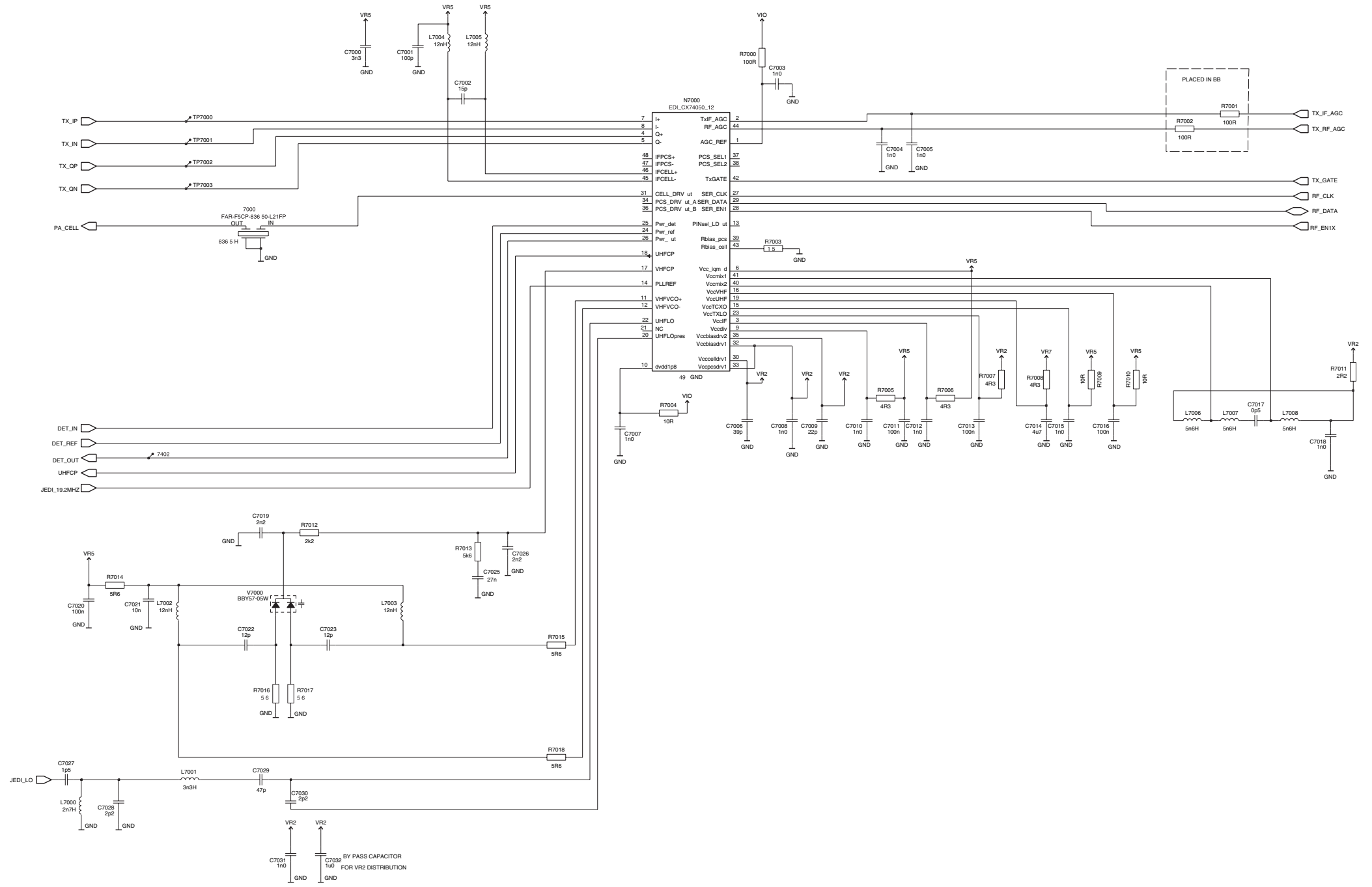

Receiver

Version 7

SHEET 18

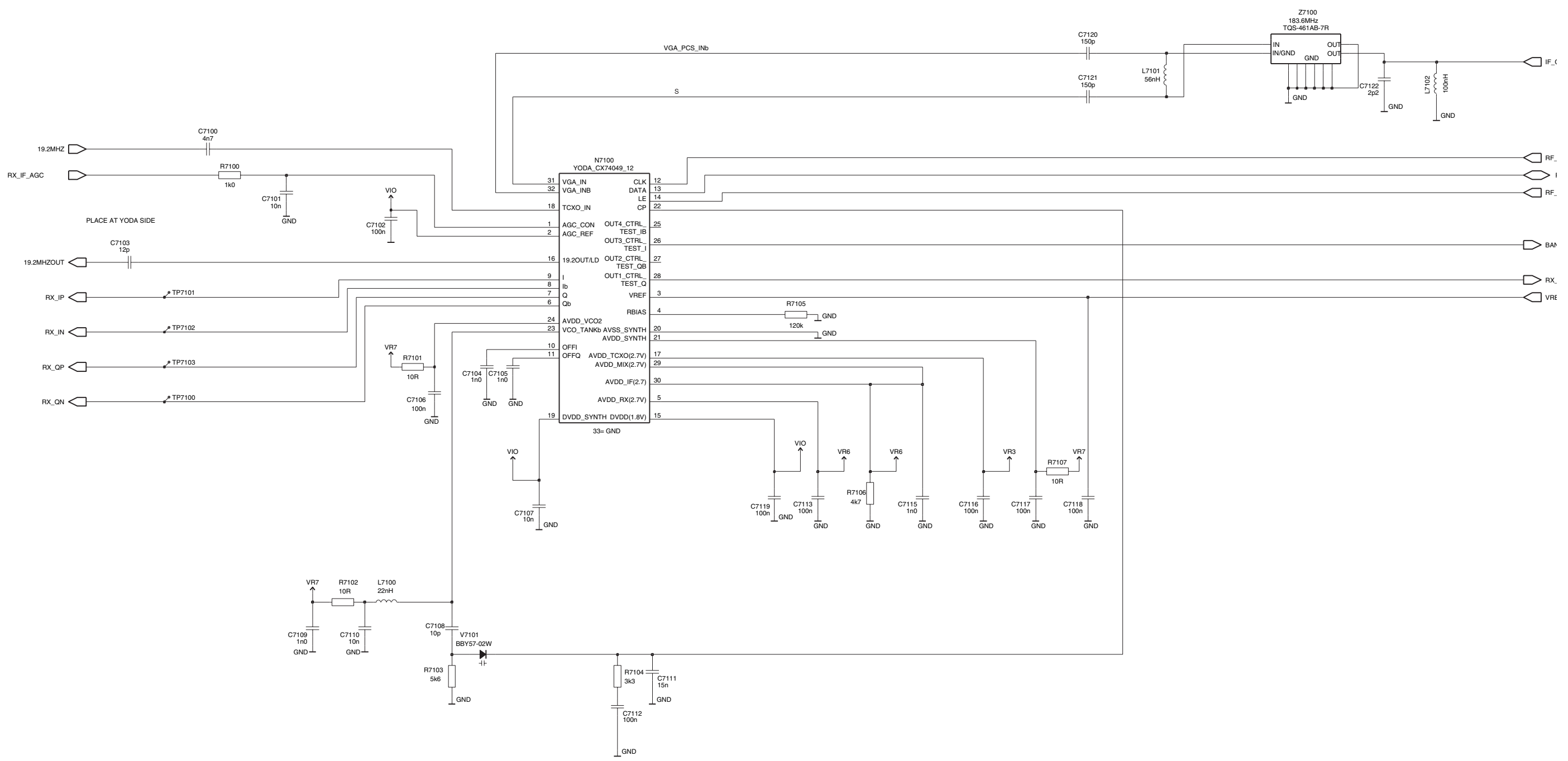

# Power Amplifier

## SHEET 19

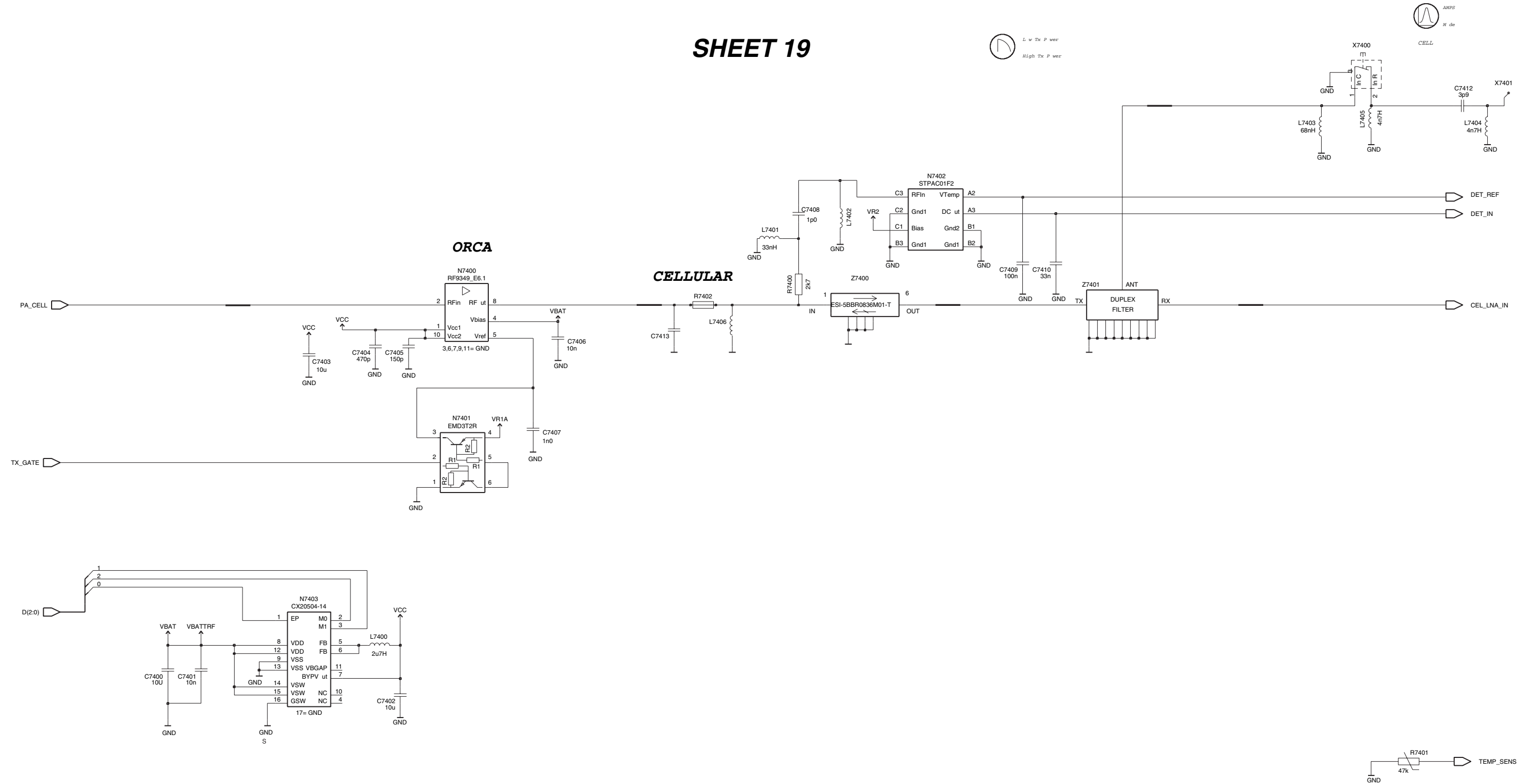

2355 Component Layout - Top

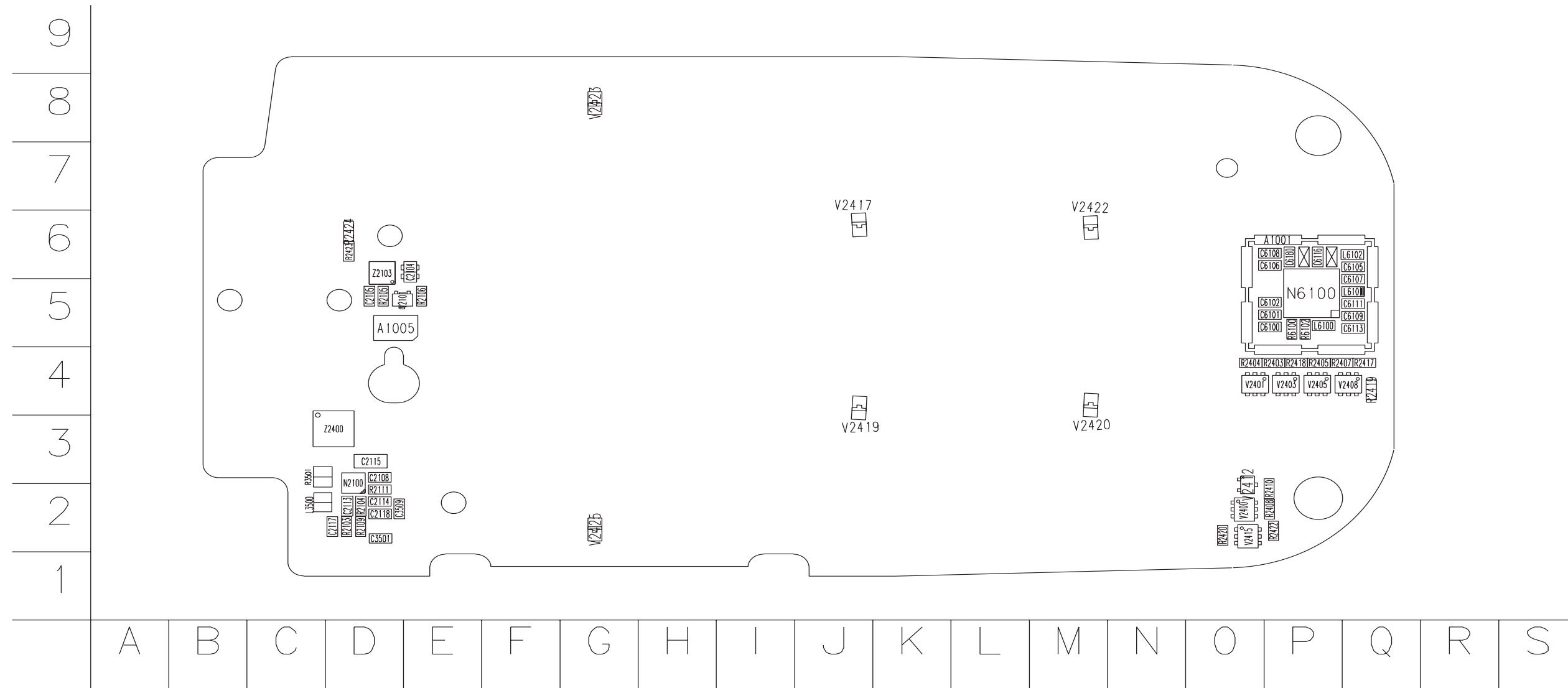

2355 Component Layout - Bottom

